

Multi Format Compact Switcher

Operating Instructions (Volume I Basic Operation)

Before operating the unit, please read this manual thoroughly and retain it for future reference.

MCS-8M

Software Version 1.00

HDMI



Owner's Record

The model and serial numbers are located on the bottom. Record these numbers in the spaces provided below. Refer to these numbers whenever you call upon your Sony dealer regarding this product.

Model No. _____ Serial No. _____

WARNING

To reduce the risk of fire or electric shock, do not expose this apparatus to rain or moisture.

To avoid electrical shock, do not open the cabinet. Refer servicing to qualified personnel only.

THIS APPARATUS MUST BE EARTHED.



This symbol is intended to alert the user to the presence of important operating and maintenance (servicing) instructions in the literature accompanying the appliance.

When installing the installation space must be secured in consideration of the ventilation and service operation.

- Do not block the ventilation slots at the left side and right side panels, and vents of the fans.
- Leave a space around the unit for ventilation.
- Leave more than 40 cm (15 ³/₄ in.) of space in the rear of the unit to secure the operation area.

When the unit is installed on the desk or the like, leave at least 10 cm (4 in.) of space in the left and right sides. Leaving 40 cm (15 ³/₄ in.) or more of space above the unit is recommended for service operation.

WARNING: THIS WARNING IS APPLICABLE FOR USA ONLY.

If used in USA, use the UL LISTED power cord specified below.

DO NOT USE ANY OTHER POWER CORD.

Plug Cap	Parallel blade with ground pin (NEMA 5-15P Configuration)
Cord	Type SJT, three 16 or 18 AWG wires
Length	Minimum 1.5 m (4 ft. 11 in.), Less than 2.5 m (8 ft. 3 in.)
Rating	Minimum 10 A, 125 V

Using this unit at a voltage other than 120 V may require the use of a different line cord or attachment plug, or both. To reduce the risk of fire or electric shock, refer servicing to qualified service personnel.

WARNING: THIS WARNING IS APPLICABLE FOR OTHER COUNTRIES.

1. Use the approved Power Cord (3-core mains lead) / Appliance Connector / Plug with earthing-contacts that conforms to the safety regulations of each country if applicable.
2. Use the Power Cord (3-core mains lead) / Appliance Connector / Plug conforming to the proper ratings (Voltage, Ampere).

If you have questions on the use of the above Power Cord / Appliance Connector / Plug, please consult a qualified service personnel.

For the customers in the U.S.A.

This equipment has been tested and found to comply with the limits for a Class A digital device, pursuant to Part 15 of the FCC Rules. These limits are designed to provide reasonable protection against harmful interference when the equipment is operated in a commercial environment. This equipment generates, uses, and can radiate radio frequency energy and, if not installed and used in accordance with the instruction manual, may cause harmful interference to radio communications. Operation of this equipment in a residential area is likely to cause harmful interference in which case the user will be required to correct the interference at his own expense.

You are cautioned that any changes or modifications not expressly approved in this manual could void your authority to operate this equipment.

All interface cables used to connect peripherals must be shielded in order to comply with the limits for a digital device pursuant to Subpart B of Part 15 of FCC Rules.

This device complies with Part 15 of the FCC Rules. Operation is subject to the following two conditions: (1) this device may not cause harmful interference, and (2) this device must accept any interference received, including interference that may cause undesired operation.

For the customers in Canada

This Class A digital apparatus complies with Canadian ICES-003.

For the customers in Europe

This product with the CE marking complies with the EMC Directive issued by the Commission of the European Community.

Compliance with this directive implies conformity to the following European standards:

- EN55103-1 : Electromagnetic Interference (Emission)
- EN55103-2 : Electromagnetic Susceptibility (Immunity)

This product is intended for use in the following Electromagnetic Environments: E1 (residential), E2 (commercial and light industrial), E3 (urban outdoors), E4 (controlled EMC environment, ex. TV studio).

The manufacturer of this product is Sony Corporation, 1-7-1 Konan, Minato-ku, Tokyo, Japan.

The Authorized Representative for EMC and product safety is Sony Deutschland GmbH, Hedelfinger Strasse 61, 70327 Stuttgart, Germany. For any service or guarantee matters please refer to the addresses given in separate service or guarantee documents.

For kundene i Norge

Dette utstyret kan kobles til et IT-strømfordelingssystem.

For the State of California, USA only

Perchlorate Material - special handling may apply, See www.dtsc.ca.gov/hazardouswaste/perchlorate
Perchlorate Material : Lithium battery contains perchlorate.

For the customers in Taiwan only



廢電池請回收

AVERTISSEMENT

Afin de réduire les risques d'incendie ou d'électrocution, ne pas exposer cet appareil à la pluie ou à l'humidité.

Afin d'écarter tout risque d'électrocution, garder le coffret fermé. Ne confier l'entretien de l'appareil qu'à un personnel qualifié.

CET APPAREIL DOIT ÊTRE RELIÉ À LA TERRE.

AVERTISSEMENT

1. Utilisez un cordon d'alimentation (câble secteur à 3 fils)/fiche femelle/fiche mâle avec des contacts de mise à la terre conformes à la réglementation de sécurité locale applicable.
2. Utilisez un cordon d'alimentation (câble secteur à 3 fils)/fiche femelle/fiche mâle avec des caractéristiques nominales (tension, ampérage) appropriées.

Pour toute question sur l'utilisation du cordon d'alimentation/fiche femelle/fiche mâle ci-dessus, consultez un technicien du service après-vente qualifié.

Pour les clients au Canada

Cet appareil numérique de la classe A est conforme à la norme NMB-003 du Canada.

Pour les clients en Europe

Ce produit portant la marque CE est conforme à la Directive sur la compatibilité électromagnétique (EMC) émise par la Commission de la Communauté européenne. La conformité à cette directive implique la conformité aux normes européennes suivantes :

- EN55103-1 : Interférences électromagnétiques (émission)
- EN55103-2 : Sensibilité électromagnétique (immunité)

Ce produit est prévu pour être utilisé dans les environnements électromagnétiques suivants : E1 (résidentiel), E2 (commercial et industrie légère), E3 (urbain extérieur) et E4 (environnement EMC contrôlé, ex. studio de télévision).

Le fabricant de ce produit est Sony Corporation, 1-7-1 Konan, Minato-ku, Tokyo, Japon.

Le représentant autorisé pour EMC et la sécurité des produits est Sony Deutschland GmbH, Hedelfinger Strasse 61, 70327 Stuttgart, Allemagne. Pour toute question concernant le service ou la garantie, veuillez consulter les adresses indiquées dans les documents de service ou de garantie séparés.

WARNUNG

Um die Gefahr von Bränden oder elektrischen Schlägen zu verringern, darf dieses Gerät nicht Regen oder Feuchtigkeit ausgesetzt werden.

Um einen elektrischen Schlag zu vermeiden, darf das Gehäuse nicht geöffnet werden. Überlassen Sie Wartungsarbeiten stets nur qualifiziertem Fachpersonal.

DIESES GERÄT MUSS GEERDET WERDEN.

WARNUNG

1. Verwenden Sie ein geprüftes Netzkabel (3-adriges Stromkabel)/einen geprüften Geräteanschluss/einen geprüften Stecker mit Schutzkontakten entsprechend den Sicherheitsvorschriften, die im betreffenden Land gelten.
2. Verwenden Sie ein Netzkabel (3-adriges Stromkabel)/einen Geräteanschluss/einen Stecker mit den geeigneten Anschlusswerten (Volt, Ampere).

Wenn Sie Fragen zur Verwendung von Netzkabel/ Geräteanschluss/Stecker haben, wenden Sie sich bitte an qualifiziertes Kundendienstpersonal.

Für Kunden in Europa

Dieses Produkt besitzt die CE-Kennzeichnung und erfüllt die EMV-Richtlinie der EG-Kommission.

Angewandte Normen:

- EN55103-1: Elektromagnetische Verträglichkeit (Störaussendung)
- EN55103-2: Elektromagnetische Verträglichkeit (Störfestigkeit)

Für die folgenden elektromagnetischen Umgebungen: E1 (Wohnbereich), E2 (kommerzieller und in beschränktem Maße industrieller Bereich), E3 (Stadtbereich im Freien) und E4 (kontrollierter EMV-Bereich, z.B. Fernsehstudio).

Der Hersteller dieses Produkts ist Sony Corporation, 1-7-1 Konan, Minato-ku, Tokyo, Japan.

Der autorisierte Repräsentant für EMV und Produktsicherheit ist Sony Deutschland GmbH, Hedelfinger Strasse 61, 70327 Stuttgart, Deutschland. Bei jeglichen Angelegenheiten in Bezug auf Kundendienst oder Garantie wenden Sie sich bitte an die in den separaten Kundendienst- oder Garantiedokumenten aufgeführten Anschriften.

Table of Contents (this manual)

Usage PrecautionsI-7

Chapter 1 Overview

Introduction.....I-8

Names and Functions of PartsI-9

Chapter 2 Preparations

Connecting Devices.....I-15

Configuring System SettingsI-17

Configuring Video Signal SettingsI-19

Configuring Audio Signal Settings.....I-21

Configuring Multi Viewer Settings.....I-23

Chapter 3 Basic Operations

Switching VideoI-25

 Cross-Point Button SwitchingI-25

 Checking the Preview Video before Switching with the

 CUT Button.....I-25

 Applying Effects while Switching (Mix/Effect)I-26

 Configuring the Transition RateI-27

 Selecting Effects with the Numeric Keypad

 (Direct Selection)I-27

Composing Images with KeysI-28

 Composing Images with Luminance Keys.....I-29

 Composing Images with Chroma KeysI-30

Mixing AudioI-32

Snapshots.....I-34

Saving and Selecting SettingsI-35

Appendix

Effect Pattern List.....I-37

TroubleshootingI-38

Maintenance.....I-39

SpecificationsI-39

IndexI-43

Table of Contents (Volume II Advanced Settings)

(CD-ROM manual)

Chapter 1 Overview

Introduction

Chapter 2 Video Switching

Overview

Setting the Transition Type

General Transition Settings ([Misc] menu)

Bus Delegation

Setting Wipes

Setting DME Wipes

Details on [Effect] Menu

Setting Keys

Details on [Key] Menu

Chapter 3 Audio Mixing

Overview

Details on [Audio Channel] Menu

Chapter 4 Input Image Freezing and Frame Memory

Overview

Freezing Input Images

Selecting Frame Memory for Use as Frame Memory
Video (FM)

Saving Images to Frame Memory

Importing and Exporting Images

Chapter 5 Importing and Exporting Files

Importing and Exporting Configuration Data

Importing and Exporting Snapshots

Formatting a USB Flash Drive

Chapter 6 3D System

Overview

Making the Necessary Settings

Chapter 7 Controlling External Devices

Enabling/Disabling Operation from External Devices

Connecting with External Devices

Details on [GPI/Tally] Menu

Chapter 8 Setup ([Setup] Menu)

Overview

System Setup (System)

Audio Setup (Audio)

Video Input Setup (Video (Input))

Assigning Video Input Signals to the Cross Point Buttons (Video (XPT))

Video Output Setup (Video (Output))

Setup of Other Video Related Items (Video (Misc))

Displaying Various Information (Information)

Installing Application Software and Firmware (Install)

Appendix

Message List

Index

About This Manual

This manual describes the preparations necessary to use this unit and its basic operations.

Basic video switching and composition operations and audio mixing can be performed by following the procedure in this manual.

For details on advanced settings and operations, see the “Operating Instructions (Volume II Advanced Settings).”

How to Read the Manual

Notes on setting values

Setting values that appear in bold indicate factory default settings.

Example:

Knob	Parameter	Meaning	Setting values
V3	Format	Signal format	108059 , 108050, 720p59, 720p50, 480i59, 576i50, Test1, Test2, Test3
V4	Aspect	Aspect ratio	16:9 , 4:3

About references

References to the Operating Instructions (Volume II Advanced Settings) are indicated by the → mark as follows.

Example 1:

POS (position) button (→ *Advanced Settings*)

Example 2:

For details, see “Message List” (→ Advanced Settings).

To find information on a specific topic

See “*Index*” (page I-43) at the end of this manual.

The index indicates whether the information can be found in “Volume I Basic Operation” or “Volume II Advanced Settings” and the corresponding page numbers.

Usage Precautions

Note on Faulty Pixels on the LCD Panel

The LCD panel fitted to this unit is manufactured with high precision technology, giving a functioning pixel ratio of at least 99.99%. Thus a very small proportion of pixels maybe “stuck”, either always off (black), always on (red, green, or blue), or flashing. In addition, over a long period of use, because of the physical characteristics of the liquid crystal display, such “stuck” pixels may appear spontaneously. These problems are not a malfunction. Note that any such problems have no effect on recorded data.

Using the CD-ROM Manual

The supplied CD-ROM includes operation manuals (Japanese, English, French, German, Italian, Spanish, Simplified Chinese, Korea and Portuguese versions).

Preparations

The following program must be installed on your computer in order to read the Operating Instructions contained in the CD-ROM.

- Adobe Reader Version 6.0 or higher

Memo

If Adobe Reader is not installed, it may be downloaded from the following URL:
<http://www.adobe.com>

Adobe and Adobe Reader are trademarks of Adobe Systems Incorporated in the United States and/or other countries.

To Read the CD-ROM Manual

To read the operation manual contained in the CD-ROM disc, do the following:

- 1** Insert the CD-ROM disc in your CD-ROM drive.

A cover page appears automatically in your browser. If it does not appear automatically in the browser, double click the index.htm file on the CD-ROM disc.
- 2** Select and click the operation manual that you want to read.

The selected file opens.

Memo

The files may not be displayed properly, depending on the version of Adobe Reader. In such a case, install the latest version you can download from the URL mentioned in “Preparations” above.

Note

If you have lost or damaged the CD-ROM, you can purchase a new one to replace it. Contact your Sony service representative.

Introduction

The MCS-8M Multi Format Compact Switcher is a compact switcher that can be used in SD, HD, and 3D systems. This unit allows you to perform video switching with added effects and audio mixing via simple operations.

System configuration example: Live recording / production system (HD system)

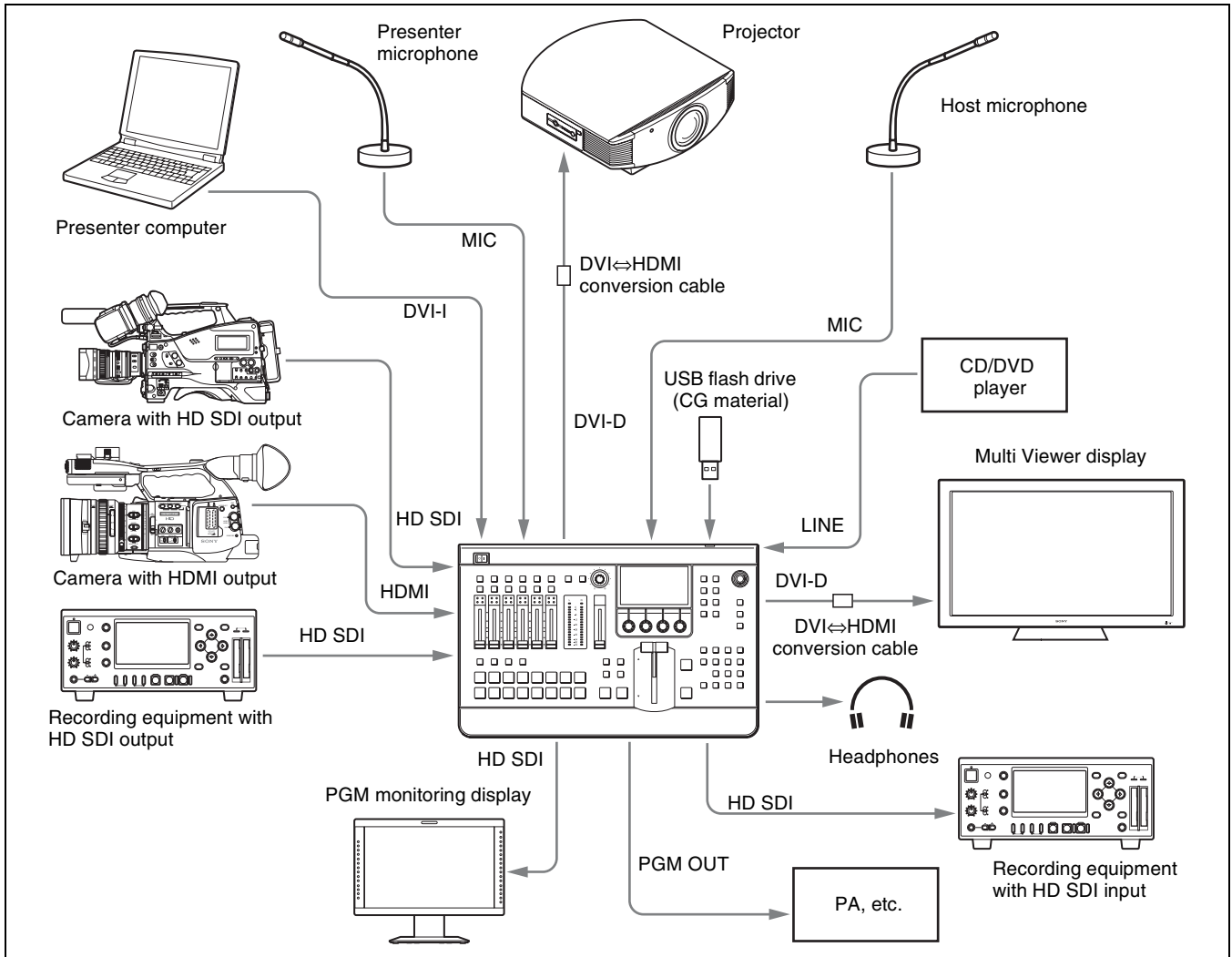

For details on configurations for SD or 3D systems, see "System Configuration Examples" (→ Advanced Settings).

Names and Functions of Parts

Front Panel

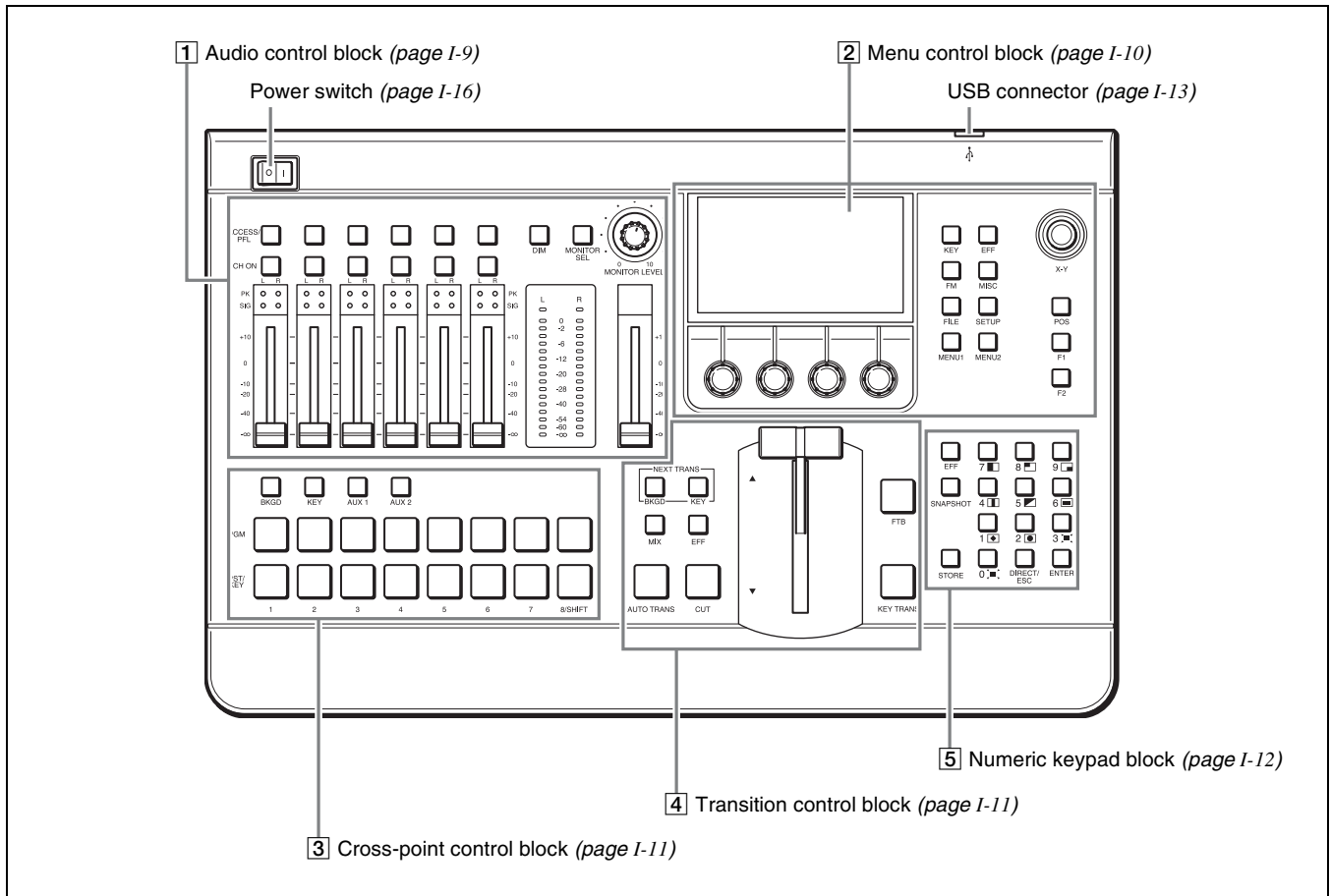

1 Audio Control Block

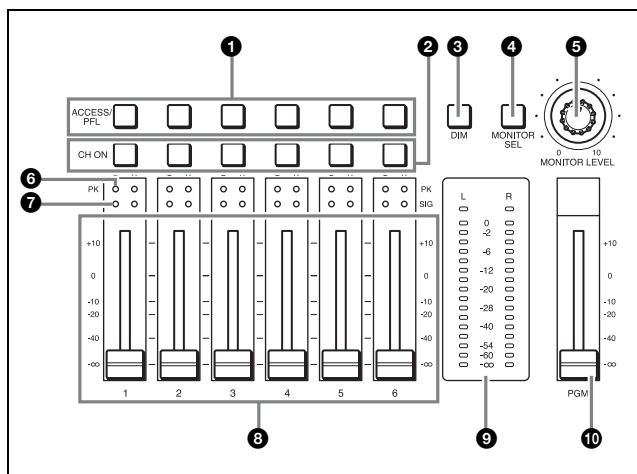

- 1 ACCESS/PFL (access/pre-fade listen) buttons (page I-33, → **Advanced Settings**)
- 2 CH ON (channel on) buttons (page I-32)
- 3 DIM (dimmer) button (page I-33)
- 4 MONITOR SEL (monitor select) button (page I-33)
- 5 MONITOR LEVEL adjustment knob (page I-33)
- 6 Peak indicator (page I-22)
- 7 Input signal indicator (page I-22)
- 8 Channel faders (pages I-21, I-32)
- 9 Audio level meters (page I-33)
- 10 Program fader (page I-32)

2 Menu Control Block

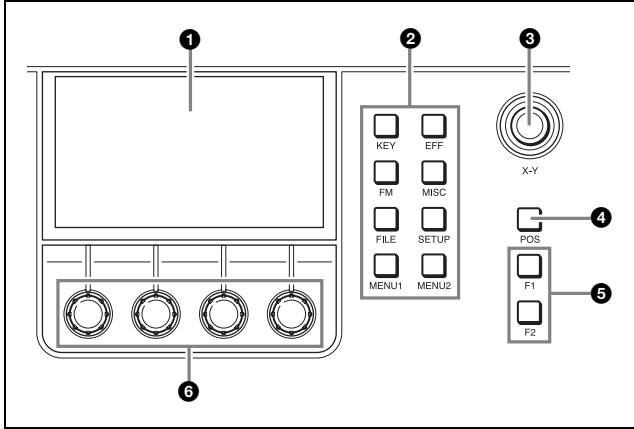

1 Menu display

2 Menu selection buttons

Display a menu that corresponds with the button pressed.

- **KEY button** (page I-29)
Displays the [Key] menu. (→ *Advanced Settings*)
- **EFF (effect) button**
Displays the [Effect] menu. (→ *Advanced Settings*)
- **FM (frame memory) button**
Displays the [Frame Memory] menu.
(→ *Advanced Settings*)
- **MISC (miscellaneous) button**
Displays the [Misc] menu. (→ *Advanced Settings*)
- **FILE button**
Displays the [File] menu. (→ *Advanced Settings*)
- **SETUP button** (pages I-17 to I-23)
Displays the [Setup] menu. (→ *Advanced Settings*)
- **MENU1 and 2 buttons (for future expansion)**

3 X-Y pointer (→ *Advanced Settings*)

4 POS (position) button (→ *Advanced Settings*)

5 F1 and F2 buttons (for future expansion)

6 Adjustment knobs 1 to 4 (V1 to V4) (page I-11)

Viewing the menu screen

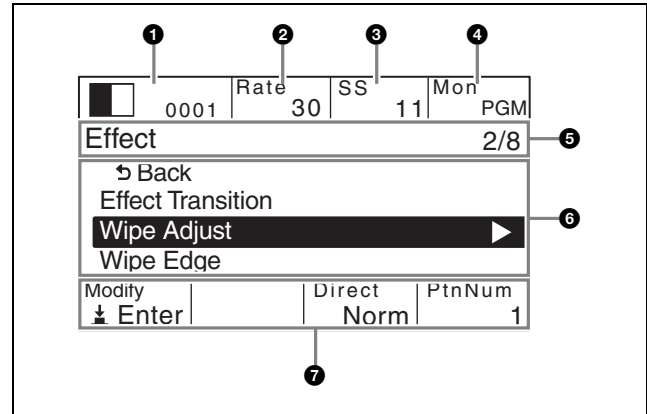

1 Effect pattern area (page I-37)

Displays the effect pattern icon and number currently selected for the effect transition.

2 Transition rate area (page I-27)

Displays the transition rate of the current effect transition.

3 Snapshot area (page I-34)

4 Audio monitor area (page I-33)

5 Menu name area

Left: Displays the name of the current menu.

Right: Displays the item number of the currently selected menu item or a message (→ *Advanced Settings*).

6 Items area

Displays the menu items.

7 Parameters area

Displays the parameter names and setting values.

Menu operations

When you press a menu selection button or an ACCESS/PFL button, setting items and values appear in the parameters area at the bottom of the screen. You can use the corresponding adjustment knobs to perform adjustments and selections.

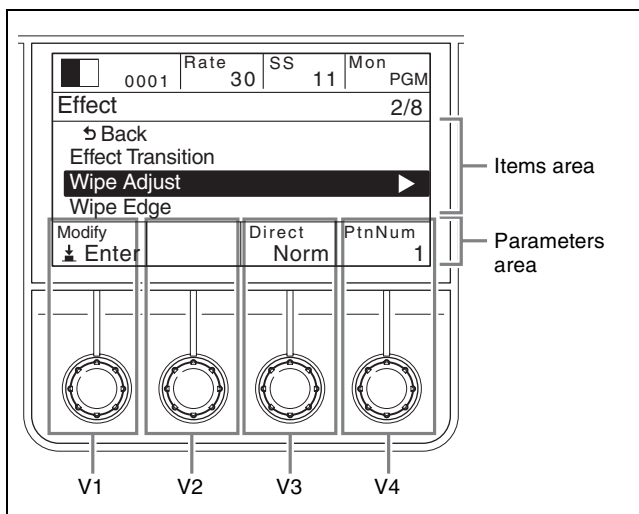

Basic adjustment knob operations

Items area

Turn the V1 knob left or right to move the cursor up or down.

If the ► icon appears for an item, pressing the V1 knob moves to the sub menu of that item.

Parameters area

Turn the V2 to V4 knobs left or right to increase, decrease, or cycle through setting values.

You can make incremental adjustments to parameters in the [Effect] menu, [Key] menu (excluding some parameters in the [Resizer] menu), and the [Misc] menu that include decimal number values by turning the knobs while pressing them.

If an action (saving, applying of setting values, etc.) is associated with the respective item, pressing the knob performs this action.

3 Cross-Point Control Block

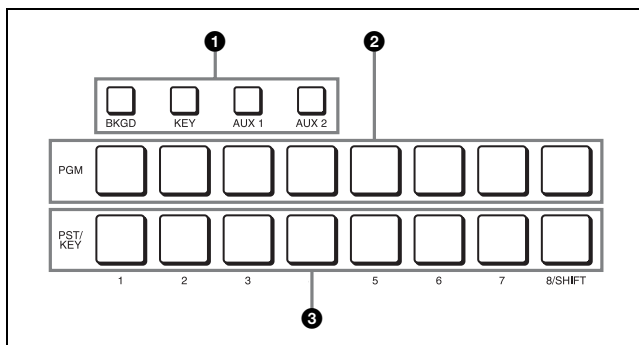

1 Bus delegation buttons

(→ *Advanced Settings*)

- **BKGD (background) button** (page I-35)
- **KEY button** (pages I-29, I-30, I-35)
- **AUX 1 and 2 (auxiliary) buttons** (→ *Advanced Settings*)

2 PGM (program) cross-point buttons 1 to 8/SHIFT

3 PST/KEY (preset/key) cross-point buttons 1 to 8/SHIFT

4 Transition Control Block

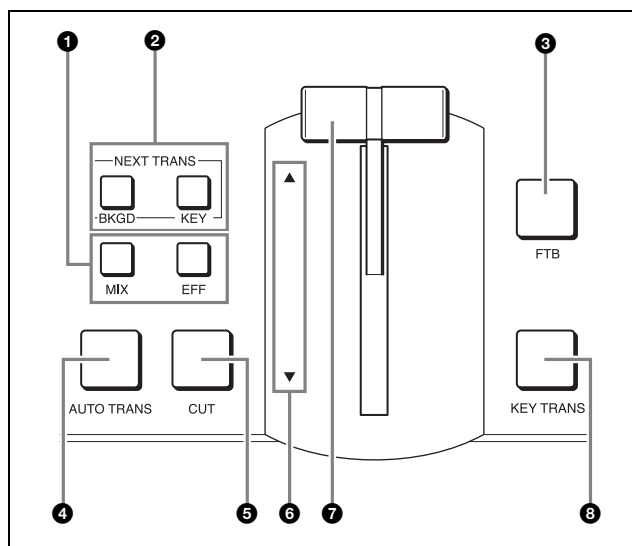

1 Transition type selection buttons

- **MIX button** (pages I-26, I-27)
- **EFF (effect) button** (pages I-26, I-27)

2 Next transition selection buttons

- **BKGD (background) button** (page I-12)
- **KEY button** (pages I-12, I-29, I-30)

3 FTB (fade-to-black) button

When you press the FTB button, the current program output image will fade out to a black screen. When you press the FTB button again, the original image will fade in from the black screen.

4 AUTO TRANS (auto-transition) button

(page I-26)

5 CUT button

(page I-26)

6 Transition indicators

(page I-27)

- 7 Fader lever (page I-26)
- 8 **KEY TRANS (key transition) button**
(→ *Advanced Settings*)

Using the next transition selection buttons

Turn on (i.e., light) the buttons by pressing them to specify which part of the video is switched at the next transition.

Next transition selection button	Operation
BKGD	The background video is switched at the next transition.
KEY	The key is inserted or removed at the next transition. If the key is not currently inserted, it is inserted at the next transition. If the key is inserted, it is removed at the next transition.
BKGD+KEY (simultaneous)	The background video is switched and the key is inserted or removed at the next transition.

Tip

When the AUX 1 or AUX 2 button is selected (i.e., lit) in the bus delegation buttons, the next transition is fixed at BKGD.

5 Numeric Keypad Block

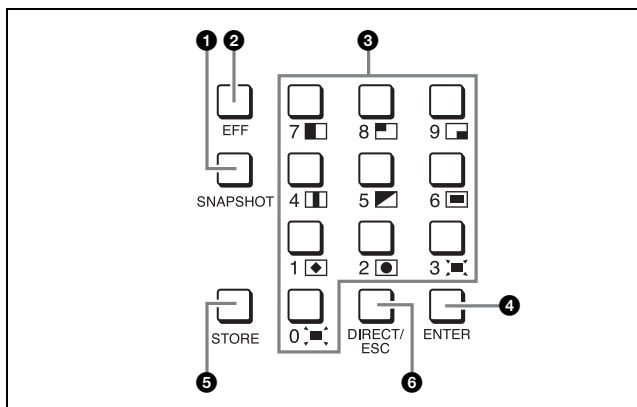

- 1 **SNAPSHOT button** (page I-34)
- 2 **EFF (effect) button** (page I-27)
- 3 **Numeric buttons (0 to 9)** (page I-27)
- 4 **ENTER button** (pages I-28, I-34)
- 5 **STORE button** (page I-34)
- 6 **DIRECT/ESC (direct/escape) button** (page I-27)

Entering numeric values

The numeric buttons are used to enter numeric values for operations such as specifying effect pattern numbers and saving or recalling snapshots.

- 1 **Press the EFF button or SNAPSHOT button to light it.**
(When specifying an effect pattern number, be sure to turn off the DIRECT/ESC button.)
- 2 **Press the numeric buttons (0 to 9) to enter the numeric value.**
The entered value appears in white at the top of the menu screen.
- 3 **Press the ENTER button to confirm.**
The numeric value appears in orange after it is confirmed.

Tip

If you press the DIRECT/ESC button before pressing the ENTER button after entering the numeric value, the value will be canceled.

Rear Panel

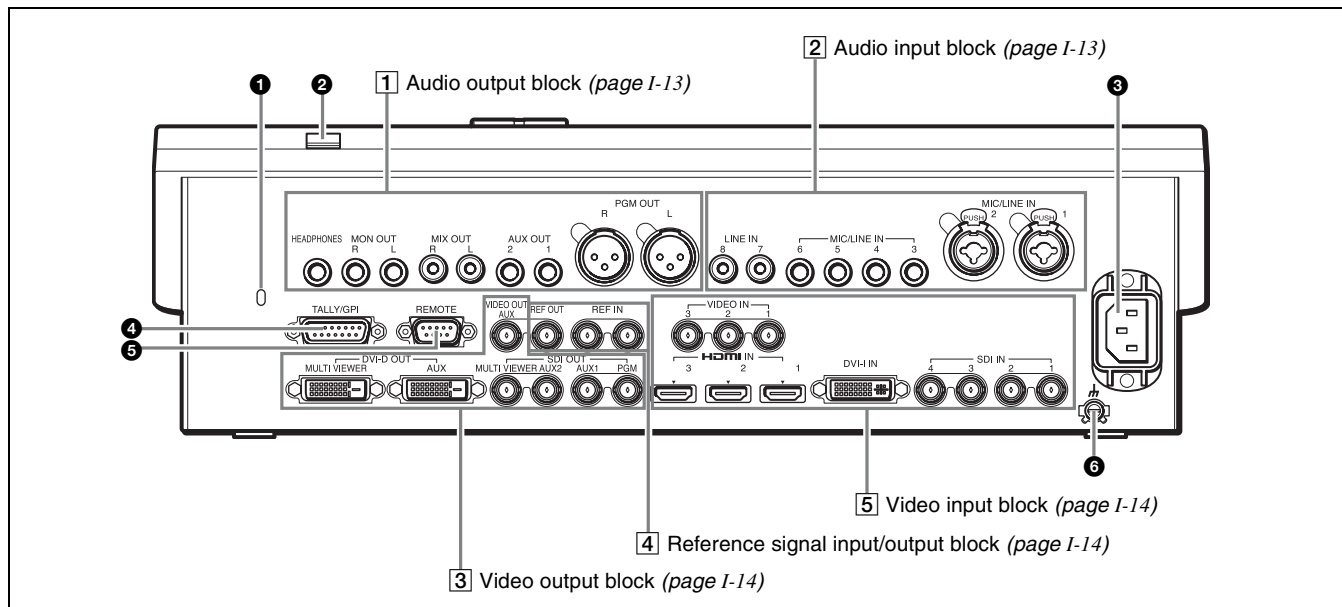

1 Anti-theft cable slot

Connect a commercially available anti-theft cable (3 mm × 7 mm) here to prevent theft.

2 USB connector

Connect a USB flash drive here.

3 AC IN (power input) connector (page I-16)

4 TALLY/GPI connector (15-pin D-sub, male) (page I-42)

5 REMOTE connector (RS-232C, 9-pin D-sub, male) (page I-42)

6 Ground connector

Connect the system grounding wire here.

4 AUX OUT (auxiliary output) 1 and 2 connectors (TRS phone) (→ Advanced Settings)

5 PGM OUT (program output) L and R connectors (XLR, male) (page I-33)

2 Audio Input Block

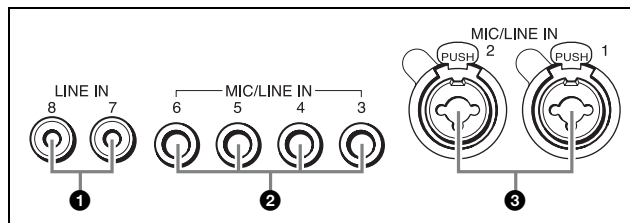

1 LINE IN (line input) 7 and 8 connectors (phono jack) (page I-21)

2 MIC/LINE IN (microphone/line input) 3 to 6 connectors (TRS phone) (page I-21)

3 MIC/LINE IN (microphone/line input) 1 and 2 connectors (XLR, female/TRS phone combo) (page I-21)

These do not supply power (e.g., for condenser microphones).

1 Audio Output Block

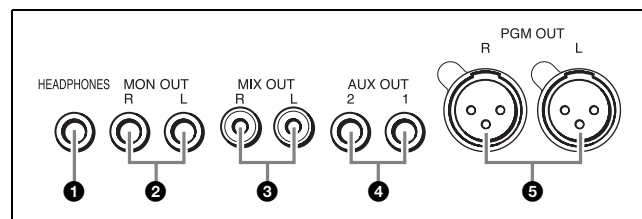

1 HEADPHONES connector (standard stereo phone) (page I-33)

2 MON OUT (monitor output) L and R connectors (TRS phone) (page I-33)

3 MIX OUT (mix output) L and R connectors (phono jack) (→ Advanced Settings)

3 Video Output Block

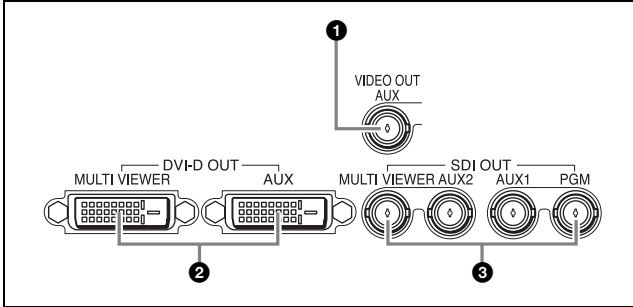

1 VIDEO OUT AUX (video output auxiliary) connector (BNC type) (→ *Advanced Settings*)

This output is used for confirming video.

2 DVI-D OUT (DVI-D output) connectors (DVI-D type)

- MULTI VIEWER connector (*page I-23*)
- AUX (auxiliary) connector (→ *Advanced Settings*)

Outputs 1080i/59.94, 1080i/50, 720p/59.94, and 720p/50 signals.

3 SDI OUT (SDI output) connectors (BNC type)

- MULTI VIEWER connector (*page I-23*)
- AUX (auxiliary) 1 and 2 connectors (→ *Advanced Settings*)
- PGM (program) connector (*page I-33*)

4 Reference Signal Input/Output Block

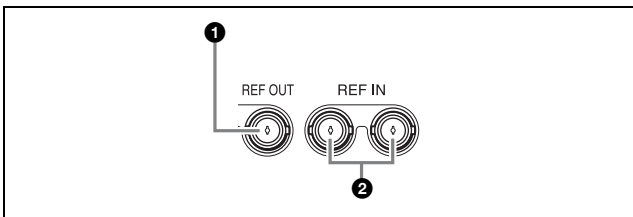

1 REF OUT (reference signal output) connector (BNC type) (→ *Advanced Settings*)

2 REF IN (reference signal input) connectors (BNC type)

Input an external reference sync signal here. One of the connectors can be used as a loop-through output connector. If you will not be using loop-through output, terminate the connector with a 75 Ω terminator. (*page I-16*)

5 Video Input Block

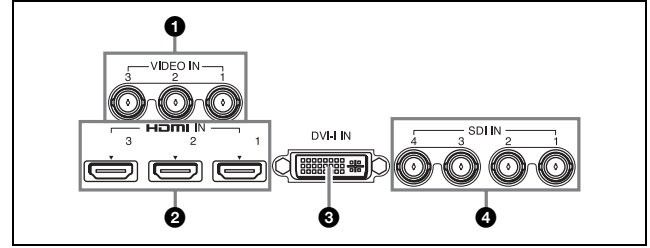

1 VIDEO IN (video input) 1 to 3 connectors (BNC type) (*page I-19*)

2 HDMI IN (HDMI input) 1 to 3 connectors (*page I-19*)

3 DVI-I IN (DVI-I input) connector (DVI-I type) (*page I-19*)

4 SDI IN (SDI input) 1 to 4 connectors (BNC type) (*page I-19*)

Connecting Devices

Connect each device to the rear panel of the unit.

Connection example: HD system

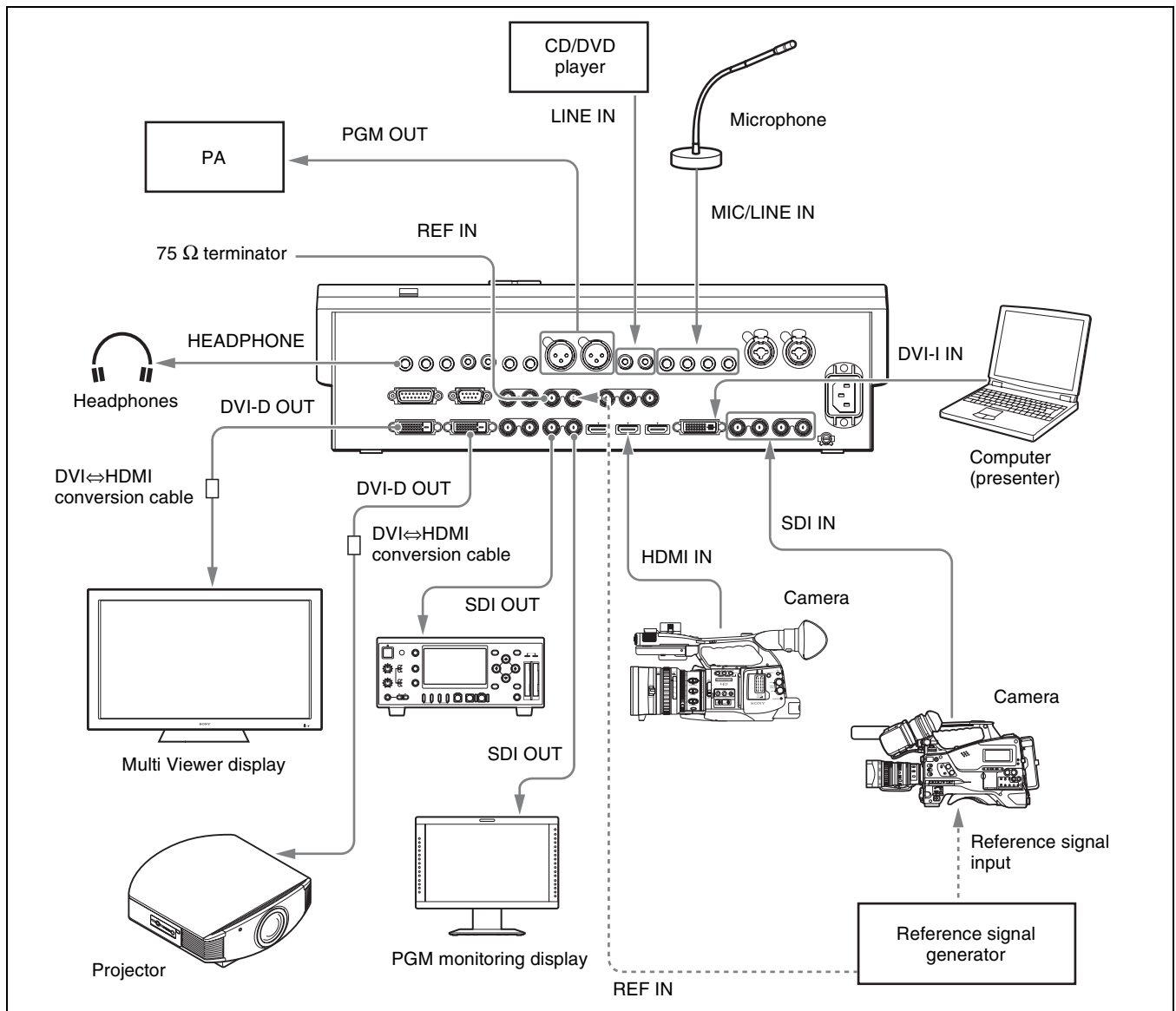

Notes

- When you are using a reference signal generator, and do not want to perform loop-through output of the reference signal input to one of the REF IN connectors of the unit, attach a 75 Ω terminator to the other connector (see page I-14). In addition, be sure to install termination resistors of 75 Ω on each device connected to the unit. For details on how to install the termination resistors, refer to the operating instructions for each device.
- When the unit is connected to a device that cannot input external reference signals, you can enable synchronization by enabling the frame synchronizer function of the SDI input connector connected to the device (default: enabled). For details on configuration, see the “Operating Instructions (→ Advanced Settings).” This is always enabled for the VIDEO IN 1 to 3 connectors.

Turning the Unit On/Off

Turning the unit on

- 1 Connect the power cord (sold separately) to the AC IN connector on the rear panel of the unit, and connect the other end of the cord to an AC power supply.
- 2 Set the power switch to the **I** position.

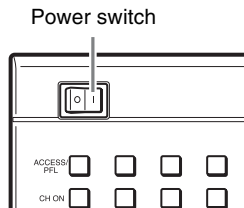

The unit turns on and starts up.
After startup is complete, a menu screen appears in the menu display and the unit is ready for operations.

Tip

The [Misc] (miscellaneous) menu appears after startup is complete.

- 3 Raise or lower the fader lever all the way up or down.

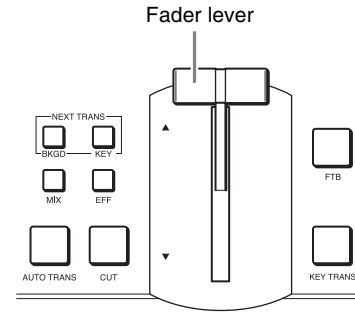

Turning the unit off

Set the power switch to the **O** position.

Note

When you turn off the unit, the configurations for the current effects, keys, and setup are not saved. To save the current configurations, perform [Startup Define] in the [Setup] menu.

For details on this operation, see “Saving Settings” (page I-35).

Configuring System Settings

Configure the system mode, system date and time, and other system settings in the menu control block.

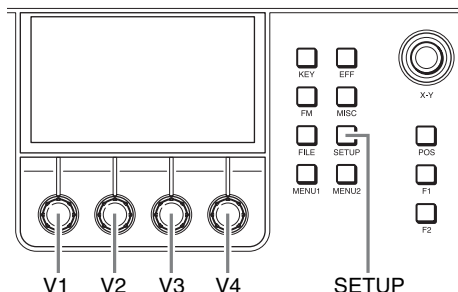

For details on operations, see "Menu operations" (page I-11).

Configuring the Signal Format and Aspect Ratio

Specify the image signal format and aspect ratio to be used by the unit.

- 1 Press the SETUP button to display the [Setup] menu.
- 2 Turn the V1 knob to select [System], and press the knob.

0001	Rate 30	SS	Mon PGM
Setup			2/11
Startup Define			
System ▶			
Audio ▶			
Video (Input) ▶			
Select			
Enter			

- 3 Turn the V1 knob to select [System Format], and select the signal format and aspect ratio with the respective knobs.

0001	Rate 30	SS	Mon PGM
System			1/8
↵ Back			
System Format			
3D Mode			
System Reference			
Select		Format 108059	Aspect 16:9

Knob	Parameter	Meaning	Setting values
V3	Format	Signal format	108059, 108050, 720p59, 720p50, 480i59, 576i50, Test1, Test2, Test3
V4	Aspect	Aspect ratio	16:9, 4:3

Notes on setting values

108059: 1080i/59.94 (HD mode)

108050: 1080i/50 (HD mode)

720p59: 720p/59.94 (HD mode)

720p50: 720p/50 (HD mode)

480i59: 480i/59.94 (SD mode)

576i50: 576i/50 (SD mode)

Test1: Used for tests.¹⁾

Test2: Used for tests.

Test3: Used for tests.

1) When [Test1] is selected while VGA signals (640 × 480/59.94p, 60p) are input to HDMI IN 1 to 3, and you select HDMI inputs 1 to 3 using the PGM cross-point buttons 6 to 8, 480i/59.94 signals will be output to PGM OUT.

Note

Under normal circumstances, do not use the Test1 to Test3 settings as they are intended for tests. Functioning and performance are not guaranteed if you use Test1 to Test3.

- 4 Press the V3 or V4 knobs.

A confirmation message appears.

- 5 Press the V3 knob.

		OK	
--	--	----	--

The confirmation message disappears.

- 6 Turn off the unit and turn it on again.

The unit will restart with the specified signal format and aspect ratio applied.

Notes

- When the signal format is set to an HD mode, the 4:3 aspect ratio cannot be selected.
- To save effects, keys, and other setup configurations, perform [Startup Define] in the [Setup] menu before turning off the unit (*see page I-35*).
- If you want to configure other settings that require a system restart, configure all of the settings before restarting the unit.

Configuring the Date and Time

Configure the unit's internal clock.

- 1 Press the SETUP button to display the [Setup] menu.
- 2 Turn the V1 knob to select [System], and press the knob.

0001	Rate 30	SS	Mon PGM
Setup			2/11
Startup Define			
System ▶			
Audio ▶			
Video (Input) ▶			
Select			
↓ Enter			

- 3 Turn the V1 knob to select [Date], and set the date with the respective knobs.

0001	Rate 30	SS	Mon PGM
System			6/8
Date			
Time			
LCD Backlight			
↵ Back			
Select	Year	Month	Day
	2011	1	1

Knob	Parameter	Meaning	Setting values
V2	Year	Year	2000 to 2099
V3	Month	Month	1 to 12
V4	Day	Day	1 to 31

- 4 Press the V2, V3, or V4 knobs.

- 5 Turn the V1 knob to select [Time], and set the clock with the respective knobs.

0001	Rate 30	SS	Mon PGM
System			7/8
Date			
Time			
LCD Backlight			
↵ Back			
Select		Hour	Min
		12	0

Knob	Parameter	Meaning	Setting values
V3	Hour	Hour	0 to 23
V4	Min	Minute	0 to 59

- 6 Press the V3 or V4 knobs.

Configuring Video Signal Settings

Configure settings for handling video signals on the unit.

Assigning Video Signals to the Cross-Point Buttons

Assign the video signals that are input to the video input connectors on the rear panel of the unit and the unit's internal signals to cross-point buttons 1 to 8 (PGM and PST/KEY) in the cross-point control block.

Signal name	Description
SDI 1 to 4	The signals that are input differ depending on the system mode. For SD mode: Assign the video of the SDI signals that are input to the SDI IN 1 to 4 connectors. For HD mode: Assign the video of the HD SDI signals that are input to the SDI IN 1 to 4 connectors.
HDMI 1 to 3	For HD mode: Assign the video of the HDMI signals that are input to the HDMI 1 to 3 connectors. Notes <ul style="list-style-type: none"> These signals cannot be used in SD mode. Content with High-bandwidth Digital Content Protection (HDCP) cannot be used.
VIDEO 1 to 3	For SD mode: Assign the video of the analog composite signals that are input to the VIDEO 1 to 3 connectors. Note These signals cannot be used in HD mode.
DVI-I	The signals that are input differ depending on the system mode. Assign the video of the DVI-I signals that are input to the DVI-I connector. Analog: XGA (1024 × 768) 60 Hz, SXGA (1280 × 1024) 60 Hz, WXGA (1280 × 768) 60 Hz Digital: When the system format is 720p/59.94, 720p/50, 480i/59.94, 576i/50: Cannot be used. When the system format is 1080i/59.94, 1080i/50: 1080p/50, 1080p/60

Note

Only signals of the format that is specified under [System Format] in the [Setup] menu can be input for SDI 1 to 4, HDMI 1 to 3, and VIDEO 1 to 3.

- 1 Press the SETUP button to display the [Setup] menu.
- 2 Turn the V1 knob to select [Video (XPT)], and press the knob.

0001	Rate 30	SS	Mon PGM
Setup			5/11
Audio			▶
Video (Input)			▶
Video (XPT)			▶
Video (Output)			▶
Select			
↓ Enter			

- 3 Turn the V1 knob to select the number of the cross-point button ([XPT Assign 1] to [XPT Assign 14]) to which you want to assign the video signal, and turn the V4 knob to select the video signal source.

0001	Rate 30	SS	Mon PGM
Video (XPT)			1/15
↵ Back			
XPT Assign 1			
XPT Assign 2			
XPT Assign 3			
Select		Source	SDI1

Knob	Parameter	Meaning	Setting values
V4	Source	Video signal	Black, SDI1 to 4, DVI, H/V1 to 3, ColBg, FM, PGM

Notes on setting values

Black: Black video

SDI1 to 4: Video input from the SDI IN 1 to 4 connectors

DVI: Video input from the DVI-I IN connector

H/V1 to 3: Video input from the HDMI IN 1 to 3 connectors or VIDEO IN 1 to 3 connectors

ColBg: Color background video

FM: Frame memory video

PGM: Program video output

- 4 Repeat step 3 for assignments to other buttons.

Tip

The following assignments are set under factory default settings.

PGM, PST/KEY cross-point button	Default setting
1	SDI1
2	SDI2
3	SDI3
4	SDI4
5	DVI
6	H/V1
7	H/V2
8	H/V3

Notes on setting values

XGA: Analog, 1024 × 768/60

SXGA: Analog, 1280 × 1024/60

WXGA: Analog, 1280 × 768/60

HDTV50: Digital, 1080p/50

HDTV60: Digital, 1080p/60

Note

Digital signals are not accepted (i.e., not supported) in 720p/59.94, 720p/50, 480i/59.94, or 576i/50 mode.

Configuring the Format of the Signal Input to the DVI-I Connector

To use DVI video inputs, configure the format of the signal input to the DVI-I connector on the rear panel of the unit.

- 1 Press the SETUP button to display the [Setup] menu.
- 2 Turn the V1 knob to select [Video (Input)], and press the knob.

0001	Rate 30	SS	Mon PGM
Setup			4/11
Audio			▶
Video (Input)			▶
Video (XPT)			▶
Video (Output)			▶
Select			
↓ Enter			

- 3 Turn the V1 knob to select [DVI], turn the V3 knob to select the signal format, and press the knob.

0001	Rate 30	SS	Mon PGM
Video (Input)			5/11
DVI			
HDMI1			
HDMI2			
HDMI3			
Select		Format XGA	Name DVI

Knob	Parameter	Meaning	Setting values
V3	Format	Signal format of DVI-I video input	XGA , SXGA, WXGA, HDTV50, HDTV60

Configuring Audio Signal Settings

Configure settings for handling audio signals on the unit.

Assigning Audio Input Signals to the Channel Faders

Assign the audio signals that are input to the audio input connectors on the rear panel of the unit to the channel faders (1 to 6).

Assigning separate audio to the left and right channels (L/R) of a fader creates a stereo fader, while assigning the same audio to the left and right channels creates a monaural fader.

Audio input signals

Signal	Description
MIC/LINE 1 to 6	Assign the audio that is input to the MIC/LINE IN 1 to 6 connectors.
LINE 7 and 8	Assign the audio that is input to the LINE IN 7 and 8 connectors.
SDI 1 to 4	Assign the embedded audio of the SDI signals that are input to the SDI IN 1 to 4 connectors. Note These signals will be assigned as stereo.
HDMI 1 to 3	For HD mode: Assign the embedded audio that is input to the HDMI 1 to 3 connectors. Note These signals will be assigned as stereo in HD mode. These signals cannot be used in SD mode.

- 1 Press the SETUP button to display the [Setup] menu.
- 2 Turn the V1 knob to select [Audio], and press the knob.

0001	Rate 30	SS	Mon PGM
Setup	3/11		
Startup Define			
System	▶		
Audio	▶		
Video (Input)	▶		
Select			
↓ Enter			

- 3 Turn the V1 knob to select the channel fader number ([Audio Input Assign 1] to [Audio Input Assign 6]) to which you want to assign the audio signal, and select the audio signals for L and R with the respective knobs.

0001	Rate 30	SS	Mon PGM
Audio	1/20		
↵ Back			
Audio Input Assign 1			
Audio Input Assign 2			
Audio Input Assign 3			
Select		Left M/L1	Right M/L1

Knob	Parameter	Meaning	Setting values
V3	Left	Left audio signal	NotUse, M/L1, M/L2, M/L3, M/L4, M/L5, M/L6, L7, L8, SDI1L, SDI2L, SDI3L, SDI4L, HDMI1L, HDMI2L, HDMI3L
V4	Right	Right audio signal	NotUse, M/L1, M/L2, M/L3, M/L4, M/L5, M/L6, L7, L8, SDI1R, SDI2R, SDI3R, SDI4R, HDMI1R, HDMI2R, HDMI3R

- 4 Repeat step 3 for assignments to other channel faders.

Tip

The following assignments are set under factory default settings.

Channel fader (L/R)	Default setting
1 (L/R)	MIC/LINE IN 1
2 (L/R)	MIC/LINE IN 2
3 (L/R)	MIC/LINE IN 3
4 (L/R)	MIC/LINE IN 4
5 (L)	MIC/LINE IN 5
5 (R)	MIC/LINE IN 6
6 (L)	LINE IN 7
6 (R)	LINE IN 8

Configuring the Mic/Line Levels for Audio Inputs

Adjustment of mic/line levels is necessary when the peak indicators light red, or when the input signal indicators do not light while audio signal input exists.

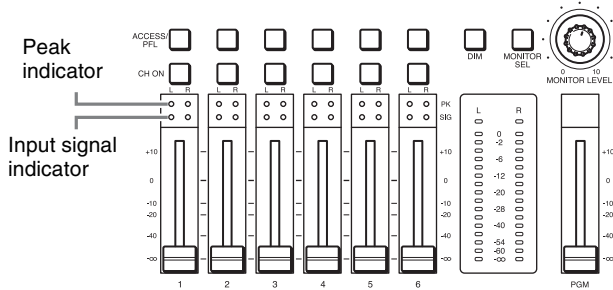

- Repeat step 3 to configure the levels for the other MIC/LINE IN connectors.

Setting example:

If a peak indicator lights at the default setting of [-20 dB], select the [+4 dB] setting. (However, the peak indicator may also light at the [+4 dB] setting in some cases.)

When the input signal indicators do not light

When the input signal indicators do not light even when audio signals are being input, the reference values for the mic/line levels are not being met. In such cases, perform the previous peak indicator procedure, and configure the lower mic/line levels for the respective channels.

Setting example:

If an input signal indicator does not light at the default setting of [-20 dB], select the [-44 dB] setting.

When the peak indicators light red

A channel fader's peak indicator will light red if the audio signal input is too loud. In this case, since the analog mic/line level exceeds the input level of the currently selected line, use the following procedure to adjust it.

- Press the SETUP button to display the [Setup] menu.
- Turn the V1 knob to select [Audio], and press the knob.

<input type="checkbox"/>	0001	Rate 30	SS	Mon PGM
Setup				3/11
Startup Define				
System ▶				
Audio ▶				
Video (Input) ▶				
Select				
↓ Enter				

- Turn the V1 knob to select the number of the MIC/LINE IN connector ([MIC/LINE 1 Level] to [MIC/LINE 6 Level]) for which you want to configure the mic/line level, and turn the V4 knob to select the level.

<input type="checkbox"/>	0001	Rate 30	SS	Mon PGM
Audio				7/20
MIC/LINE 1 Level				
MIC/LINE 2 Level				
MIC/LINE 3 Level				
MIC/LINE 4 Level				
Select			Level	
				-20dB

Knob	Parameter	Meaning	Setting values
V4	Level	Input level	-44 dB, -20 dB, +4 dB

Configuring Multi Viewer Settings

The Multi Viewer allows you to display multiple video inputs, program video outputs, and preview video outputs simultaneously on a monitor connected to the unit. A 4-screen layout and a 10-screen layout are available.

4-screen layout

1	2
3	4

10-screen layout

1	2		
3	4	5	6
7	8	9	10

(The numbers indicate the number assignments for each sub-screen.)

Multi Viewer output example: 10-screen layout

Red frames indicate the sub-screens for video inputs that are currently on air (i.e., the program video).



Note

If a frame memory key is on air, the red frame appears in the [FM-V] (video) sub-screen.

When using the Multi Viewer, specify the video output for each sub-screen.

- 1 Press the SETUP button to display the [Setup] menu.
- 2 Turn the V1 knob to select [Multi Viewer], and press the knob.

0001	Rate 30	SS	Mon PGM
Setup			8/11
Video (Misc) ▶			
Multi Viewer ▶			
GPI/Tally Information ▶			
Select			
↓ Enter			

- 3 Turn the V1 knob to select [Viewer Mode], and turn the V4 knob to select the split-screen layout.

0001	Rate 30	SS	Mon PGM
Multi Viewer			1/11
↵ Back			
Viewer Mode			
Signal Assign 1			
Signal Assign 2			
Select			Split 10

Knob	Parameter	Meaning	Setting values
V4	Split	Split-screen layout	4, 10

- 4 Turn the V1 knob to select the sub-screen ([Signal Assign 1] to [Signal Assign 10]) to which you want to assign the video signal, and turn the V4 knob to select the video signal.

0001	Rate 30	SS	Mon PGM
Multi Viewer			2/11
↵ Back			
Viewer Mode			
Signal Assign 1			
Signal Assign 2			
Select			Source PVW

Knob	Parameter	Meaning	Setting values
V4	Source	Video signal	Black, SDI1 to 4, DVI, H/V1 to 3, ColBg, FM-V, FM-K, PGM, PVW, Aux1PG, Aux1PV, Aux2PG, Aux2PV

Notes on setting values**Black:** Black video**SDI1 to 4:** Video input from the SDI IN 1 to 4 connectors**DVI:** Video input from the DVI-I IN connector**H/V1 to 3:** Video input from the HDMI IN 1 to 3 connectors or VIDEO IN 1 to 3 connectors**ColBg:** Color background video**FM-V:** Frame memory video**FM-K:** Frame memory key**PGM:** Program video output**PVW:** Preview video output**Aux1PG:** Program video output of the Aux1 bus**Aux1PV:** Preview video output of the Aux1 bus**Aux2PG:** Program video output of the Aux2 bus**Aux2PV:** Preview video output of the Aux2 bus**5** Repeat step **4** to configure the other sub-screens.**Tip**

The following video signals are assigned to each sub-screen under factory default settings.

Sub-screen	Video signal
1	PVW
2	PGM
3	SDI1
4	SDI2
5	SDI3
6	SDI4
7	DVI
8	H/V1
9	H/V2
10	H/V3

Switching Video

Switch between video signals that are input to the unit, compose images, and output programs from the PGM output connector.

This section describes simple operations for switching video and applying effects while switching.

Frequently used effects can be saved as “snapshots” and recalled when necessary. For details, see “Snapshots” (page I-34).

Cross-Point Button Switching

This is the most basic form of switching. Switching between video A and video B occurs instantly without added effects.

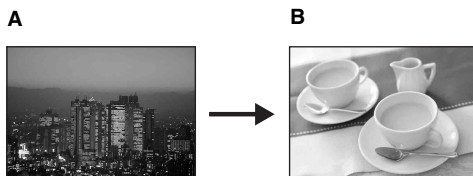

You can cut between videos by pressing a PGM cross-point button to which a different video is assigned.

- 1 In the cross-point control block, press the PGM cross-point button to which the video you want to switch is assigned.

The button you pressed lights red, and the video is output as the program output.

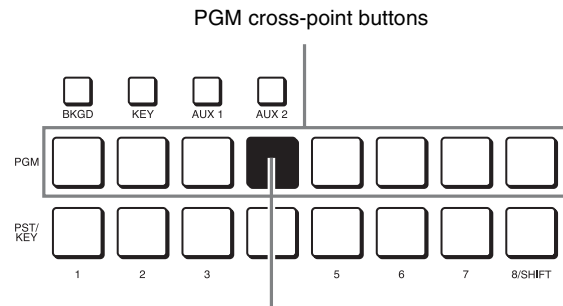

The button that is lit red indicates the current program video output.

- 2 Determine the next video to be used for program output, and press the corresponding PGM cross-point button.

The program video switches.

Checking the Preview Video before Switching with the CUT Button

Preview the next video that will be used for the program output before switching.

- 1 In the cross-point control block, press the PGM cross-point button to which the video you want to switch is assigned.
The PGM cross-point button you pressed lights red.
- 2 Press the PST/KEY cross-point button to which the next video to be used for program output (i.e., the target for switching) is assigned.

The PST/KEY cross-point button you pressed lights orange, and the selected video is used for PVW output.

3 Press the CUT button in the transition control block.

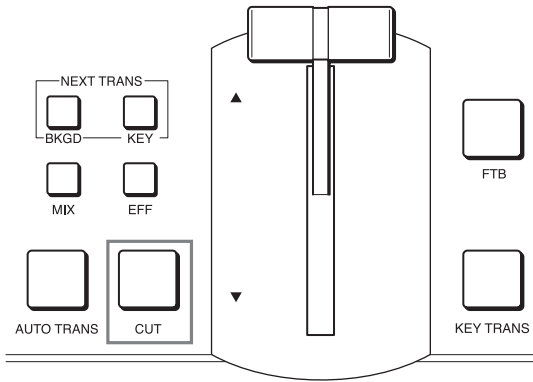

The program video interchanges with the preview video.
The lit PGM cross-point and PST/KEY cross-point buttons also interchange.

Applying Effects while Switching (Mix/Effect)

Instead of an instantaneous cut, you can gradually switch from one video to another through the various effects.

Mix (page I-27)

Transition into the next video by gradually overlapping the existing image.



Effect

You can use Wipe, NAM (non-additive mix), Slide, Squeeze, Door, Frame In/Out, Flip Tumble, PinP (picture-in-picture), Mosaic, and Defocus effects.

Example: Wipe (page I-37)

With this effect, the next video for output replaces the current program video output as if wiping it away.



Example: Frame In/Out (page I-27)

With this effect, the next video is superimposed as a frame within the current program video output and gradually expands to replace the current video.



Multiple patterns may be available for certain effects. For details on the different patterns, see "Effect Pattern List" (page I-37).

Basic operation flow

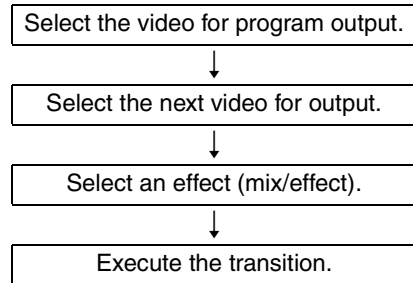

To execute the transition

Press the AUTO TRANS button in the transition control block, or operate the fader lever.

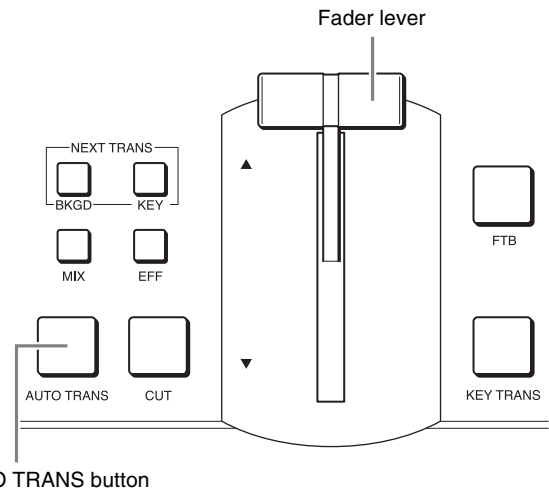

AUTO TRANS button (automatic execution)

The video switches automatically at the current speed (transition rate) setting.

You can change the transition rate under [Transition Rate (1/2)] in the [Misc] menu. For details on configuration, see "Configuring the Transition Rate" (page I-27).

Fader lever (manual execution)

The video switches over as you move the lever. Move the lever in the direction of the lit transition indicator. The transition starts, and proceeds according to the rate at which you move the lever. When the lever is completely raised or lowered, the transition is complete and the transition indicator for the opposite direction will light.

Note

If both the indicators are lit, completely raise or lower the fader lever in either direction.

Switching with mix

- 1 Press the PGM cross-point button of the video for program output.
- 2 Press the PST/KEY cross-point button for the next video for output.
- 3 Press the MIX button in the transition control block. The button lights orange.

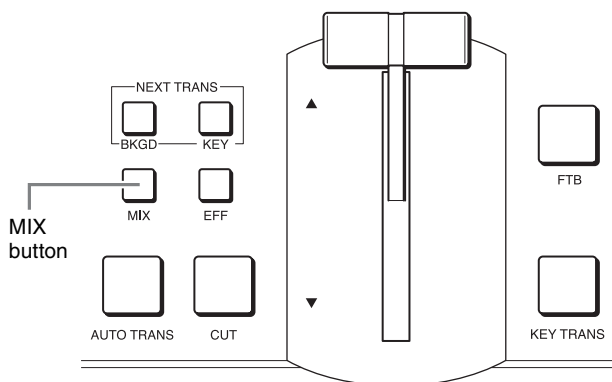

- 4 Execute the transition.

Configuring the Transition Rate

You can change the rate at which a video switches over (i.e., transition rate) when the AUTO TRANS button is used to execute a transition.

- 1 Press the MISC button to display the [Misc] menu.
- 2 Turn the V1 knob to select [Transition Rate (1/2)], and configure the transition rate with the V2 knob.

0001	Rate 30	SS	Mon PGM
Misc			1/4
Transition Rate (1/2)			
Transition Rate (2/2)			
Color BKGD			
Port Enable			
Select	Effect 30	Key 30	FTB 30

Knob	Parameter	Meaning	Setting values
V2	Effect	Effect transition	1 to 999 frames (30)
V3	Key	Key transition	1 to 999 frames (30)
V4	FTB	FTB (fade-to-black) transition	1 to 999 frames (30)

Selecting Effects with the Numeric Keypad (Direct Selection)

The following effect patterns are pre-assigned to the numeric buttons (0 to 9) in the numeric keypad block. These buttons make it easy for you to apply effects.

Numeric button	Effect pattern	Numeric button	Effect pattern
0	1251 (PinP)	5	0009 (Wipe)
1	0023 (Wipe: Diamond)	6	0021 (Wipe: Box)
2	0024 (Wipe: Circle)	7	0001 (Wipe: Horizontal)
3	1201 (Frame In/Out)	8	0005 (Wipe)
4	0017 (Wipe)	9	0007 (Wipe)

For details on specifying other effect patterns, see "Specifying effects by pattern number" (page I-28).

- 1 Press the PGM cross-point button of the video for program output.
- 2 Press the PST/KEY cross-point button for the next video for output.

- 3** Select an effect in the numeric keypad block.

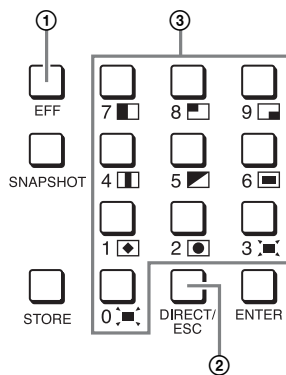

- ① Press the EFF button to light it.
 - ② If the DIRECT/ESC button is not lit, press the button to light it.
 - ③ Press the numeric button to which the effect pattern you want to use is assigned.
- 4** Execute the transition.

Specifying effects by pattern number

Perform the following to specify effects by entering effect pattern numbers.

For details on pattern numbers, see “Effect Pattern List” (page I-37).

- 1** Press the EFF button in the numeric keypad block to light it.
- 2** If the DIRECT/ESC button is lit, press the button to turn it off.
- 3** Use the numeric buttons (0 to 9) to enter the pattern number.

The pattern number entered appears at the top left of the menu screen.

- 4** Press the ENTER button.

The pattern icon of the number entered appears, and the effect pattern number changes to an orange display.

Tip

If you press the DIRECT/ESC button before pressing the ENTER button after entering the pattern number, the entry will be canceled and revert to the original pattern number.

Composing Images with Keys

Keying is a function in which part of the background image is replaced by another image or superimposed text. The following keys can be used with this unit to compose video.

Luminance key (page I-29)

Based on the brightness (luminance) of the key source¹⁾, key fill¹⁾ image B is cut out and superimposed on image A (i.e., the background).

In this composition example, the same image is selected as the key source and key fill.

- 1) The signal for cutting out the background is called a key source, and the signal for filling the cutout portion is called a key fill.



Linear key

This is a type of luminance key with a reduced variability in gain that allows more precise adjustment.

For details on operations, see “Making Detailed Adjustments to the Linear Key” (→ Advanced Settings).

Chroma key (page I-30)

A particular color (chroma) component is removed from image B, and image B is superimposed on image A (i.e., the background). Typically, a subject is shot in front of a blue screen and the portions of the background that contain blue components are later removed, leaving only the subject to be superimposed.

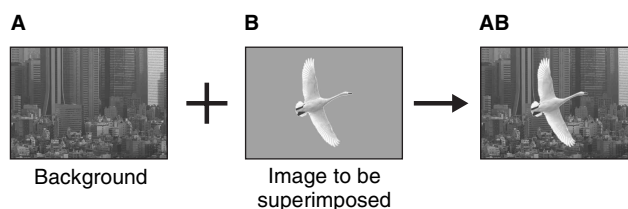

Composing Images with Luminance Keys

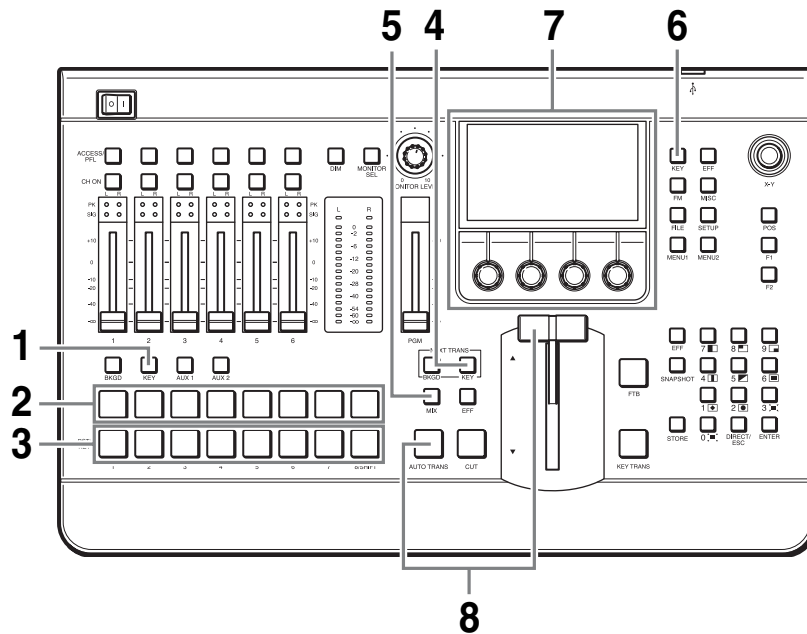

- 1** Press the KEY bus delegation button.
- 2** Press the PGM cross-point button of the video for program output.
- 3** Press the PST/KEY cross-point button of the key material (i.e., the image to be superimposed on the program video output).
- 4** Press the KEY next transition selection button.
The selected image in its “key on” state is used for PVW output.
- 5** Press the MIX button or EFF button.
- 6** Press the KEY button in the menu control block to display the [Key] menu.
- 7** Turn the V1 knob to select [Key Type Select], and turn the V4 knob to select [Lum].

Knob	Parameter	Meaning	Setting values
V4	Type	Key type selection	Lum (luminance key), Lin (linear key), Chr (chroma key)

If necessary, you can also configure the clip value (brightness), gain value, and key transparency.

For details on configuration, see “Making Detailed Adjustments to the Luminance Key” (→ Advanced Settings).

- 8** Execute the transition.

The image of the PST/KEY cross-point button is superimposed on the program video output.

You can also configure the duration for video composition (transition rate). For details on configuration, see the “Configuring the Transition Rate” (page I-27).

Luminance key settings can be saved as “snapshots” and recalled when necessary. For details, see “Snapshots” (page I-34).

0001	Rate 30	SS	Mon PGM
Key			2/27
↩ Back			
Key Transition			
Key Type Select			
Resizer			
Select		Type	Lum

Selecting the key fill and key source separately

Perform the following between step **7** and **8** of the previous procedure.

- Turn the V1 knob to select [Key Fill/Src Select], and turn the V3 knob to select [Split].

0001	Rate 30	SS	Mon	PGM
Key				4/27
Key Transition				
Key Type Select				
Resizer				
Key Fill/Src Select				
Select		Source	Fill	
		Split	Bus	

Knob	Parameter	Meaning	Setting values
V3	Source	Key source selection mode	Self, Auto , Split

- Press the PST/KEY cross-point button to be used for the key source while holding down the KEY bus delegation button.

Composing Images with Chroma Keys

This section describes how to perform “auto chroma key” where you specify a portion of the foreground video (e.g., a blue background color) and use it as a reference signal for creating the chroma key image through automatic adjustment.

You can also adjust chroma keys manually (manual chroma key). For details, see “Making Detailed Adjustments to the Chroma Key” (→ Advanced Settings).

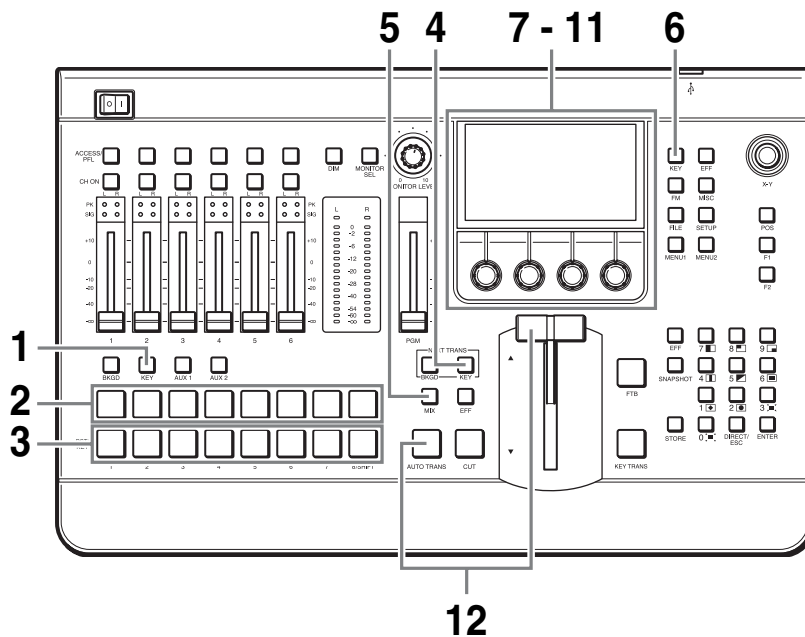

- Press the KEY bus delegation button.
- Press the PGM cross-point button of the video for program output.
- Press the PST/KEY cross-point button of the key material (i.e., the image to be superimposed on the program video output).
- Press the KEY next transition selection button.
The selected image in its “key on” state is used for PVW output.
- Press the MIX button or EFF button.

- 6 Press the **KEY** button in the menu control block to display the [Key] menu.
- 7 Turn the V1 knob to select [Key Type Select], and turn the V4 knob to select [Chr].

0001	Rate 30	SS	Mon PGM
Key 2/27			
↵ Back			
Key Transition			
Key Type Select			
Resizer			
Select		Type	Chr

Knob	Parameter	Meaning	Setting values
V4	Type	Key type selection	Lum (luminance key), Lin (linear key), Chr (chroma key)

- 8 Turn the V1 knob to select [Key Fill/Src Select], and turn the V3 knob to select [Self].

0001	Rate 30	SS	Mon PGM
Key 4/27			
Key Transition			
Key Type Select			
Resizer			
Key Fill/Src Select			
Select		Source	Fill
		Self	Bus

Knob	Parameter	Meaning	Setting values
V3	Source	Key source selection mode	Self, Auto , Split

- 9 Turn the V1 knob to select [Chromakey Auto Adj], and press the knob.

The menu changes to the [Auto Chromakey] menu for automatic chroma key adjustment.

- 10 Turn the V1 knob to select [Sample Mark], and press the V4 knob.

0001	Rate 30	SS	Mon PGM
Auto Chromakey 1/3			
↵ Back			
Sample Mark			
Sample Mark Adjust			
Auto Adjust Execute			
Select		Mark	Enter

Auto chroma key mode is enabled, and a white sample mark appears in the PVW image.



Tip

To disable auto chroma key mode, press the V4 knob again.

- 11 Turn the V1 knob to select [Sample Mark Adjust], and turn the respective knobs to move the sample mark to specify the color to remove (i.e., the reference signal for the chroma key).

You can adjust the size and position of the sample mark using the following knob operations.

0001	Rate 30	SS	Mon PGM
Auto Chromakey 2/3			
↵ Back			
Sample Mark			
Sample Mark Adjust			
Auto Adjust Execute			
Select	Pos H	Pos V	Size
	0.00	0.00	25.00

Knob	Parameter	Meaning	Setting values
V2	Pos H	Horizontal position	-100.00 to +100.00 ¹⁾ (0.00)
V3	Pos V	Vertical position	-100.00 to +100.00 ¹⁾ (0.00)
V4	Size	Size	1.00 to 100.00 (25.00)

1) The setting range will vary depending on the size setting.

- 12** Turn the V1 knob to select [Auto Adjust Execute], and press the V4 knob.

0001	Rate 30	SS	Mon PGM
Auto Chromakey			3/3
↩ Back			
Sample Mark			
Sample Mark Adjust			
Auto Adjust Execute			
Select			Start ↓ Enter

Auto chroma keying is executed using the color specified with the sample mark as a reference signal, and the composed image is output in the PVW area.

Tip

After the auto chroma keying is executed, the sample mark disappears automatically.

- 13** Execute the transition.

The image of the PST/KEY cross-point button is superimposed on the program video output.

You can also configure the duration for video composition (transition rate). For details on configuration, see the “Configuring the Transition Rate” (page I-27).

Chroma key settings can be saved as “snapshots” and recalled when necessary. For details, see “Snapshots” (page I-34).

Mixing Audio

Mix audio that is input to the unit, and output the final audio (i.e., program output) from the PGM OUT connector of the audio output block.

Input signals must be assigned to the channel faders (1 to 6) in the audio control block beforehand. For details on configuration, see “Assigning Audio Input Signals to the Channel Faders” (page I-21).

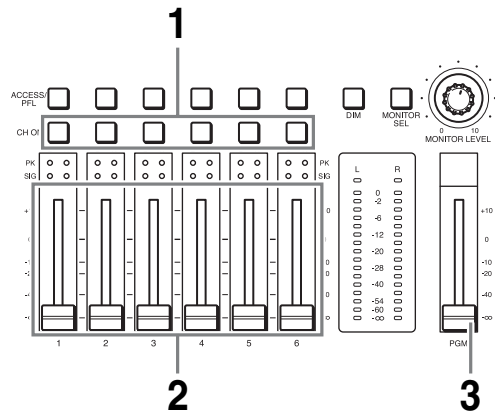

- 1** In the audio control block, press the CH ON buttons for the channels to which the audio signals you want to mix are assigned to light them.

The button lights green or turns off with each press.

CH ON button status

Button status		Meaning
Lit green	On	Audio is output
Not lit	Off (default)	Audio disabled

- 2** Adjust the audio levels using each channel fader to perform mixing.
- 3** Use the program fader to adjust the audio level of the program output.

If the peak indicators light red or the input signal indicators do not light, see “Configuring the Mic/Line Levels for Audio Inputs” (page I-22) and adjust the mic/line levels.

Switching audio for monitoring

Press the MONITOR SEL button to select [PGM]. The button lights orange for a moment and the audio for monitoring switches in the following sequence with each press.

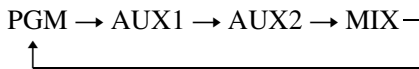

The current selection appears at the top right of the menu screen.

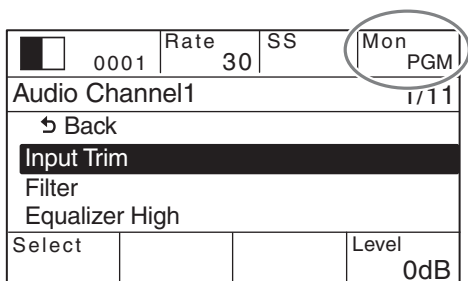

Audio for monitoring

PGM: Audio output from the PGM OUT L and R connectors

AUX1: Audio output from the AUX OUT 1 connector

AUX2: Audio output from the AUX OUT 2 connector

MIX: Audio output from the MIX OUT L and R connectors

Viewing the audio level meters

The audio level meters display the levels of the audio selected with the MONITOR SEL button within a 0 dB to -60 dB range (16 levels).

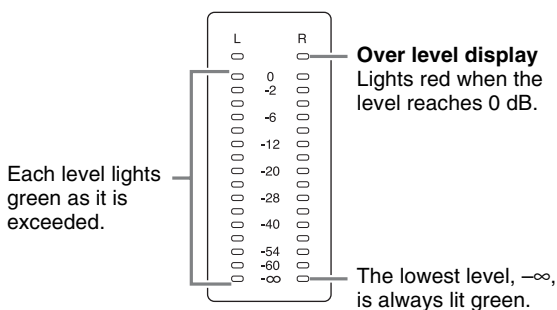

Tips

- Peak hold is performed.
- During PFL (pre-fade listen), the PFL audio levels are displayed.

Adjusting audio levels for monitoring

Use the MONITOR LEVEL adjustment knob and the DIM button to adjust the level of the audio that is output to devices connected to the MON OUT L and R connectors and the HEADPHONES connector.

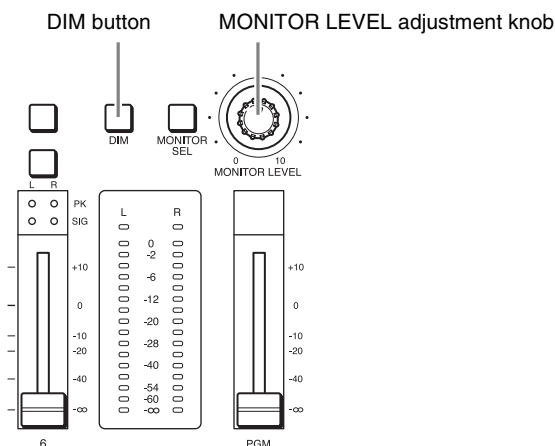

MONITOR LEVEL adjustment knob

Turn the knob to perform adjustment of the audio level for monitoring.

DIM button

Pressing the button lights it orange and enables the dimmer function, which lowers the monitor level 20 dB. Pressing the button again disables the dimmer function and returns the original monitor level.

Monitoring the Audio of a Particular Channel Only

Use the Pre-Fade Listening (PFL) function to check the audio on a channel without the channel fader adjustments. You can do this, for example, on the MON OUT L and R connectors and the HEADPHONES connector.

Hold down the ACCESS/PFL button for the channel you want to monitor for at least 0.5 seconds. While the button is held down, the audio for that channel is monitored.

When you release the ACCESS/PFL button, the monitoring is ended.

Tips

- If you press another ACCESS/PFL button for at least 0.5 second during PFL, the sound of the subsequently specified channel is added.
- This does not affect the program output, AUX output, or MIX output.

Snapshots

The snapshot function allows you to save effect and key settings for specific scenes. By saving frequently used settings as snapshots, you can quickly recall settings when necessary. Up to 20 snapshots can be saved.

The following information is stored in a snapshot.

- Cross-point button numbers
- Backgrounds/keys
- Effect patterns
- Key setting status
- Transition status

Saving Snapshots

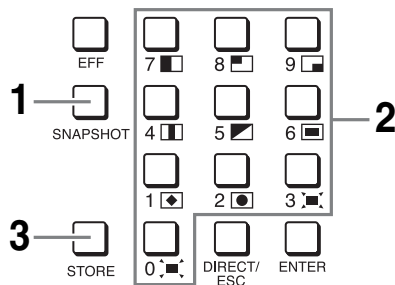

- 1 Press the SNAPSHOT button in the numeric keypad block to light it.
- 2 Use the numeric buttons to enter the number (1 to 20) under which to save the snapshot.

The number entered appears as the snapshot number in the menu screen.

Tip

If a snapshot is not currently registered to the number entered, “E” (empty) will appear to the left of the number.

- 3 Press the STORE button.

The snapshot is registered.

Tip

If you enter a number that is already in use, the previous snapshot will be overwritten.

Example: When registered to number 8

0001	Rate 30	SS 8	Mon PGM
Misc			1/4
Transition Rate (1/2)			
Transition Rate (2/2)			
Color BKGD			
Port Enable			
Select	Effect 30	Key 30	FTB 30

Snapshots can be exported to and imported from USB flash drive. For details on operations, see “Importing Snapshots” (→ Advanced Settings).

Recalling Snapshots

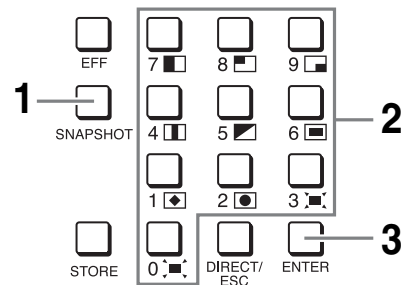

- 1 Press the SNAPSHOT button in the numeric keypad block to light it.
- 2 Use the numeric buttons to enter the number of the snapshot to recall.

The number entered appears as the snapshot number in the menu screen.

Tip

If a snapshot is not currently registered to the number entered, “E” (empty) will appear to the left of the number.

- 3 Press the ENTER button.

The snapshot is recalled.

Tip

To recall a snapshot without changing the cross-point, press the ENTER button while holding down the PGM cross-point button and/or PST/KEY cross-point button.

Bus delegation	Cross-point row	Unchanged cross-point
BKGD	PGM	PGM bus
	PST/KEY	PST bus
KEY	PGM	PGM bus
	PST/KEY	KEY bus (Fill bus and Source bus)

Saving and Selecting Settings

You can save the current settings for effects, keys, and setup.

You can also select whether to start up the unit with the saved settings or with the factory default settings.

Saving Settings

- 1 Press the SETUP button to display the [Setup] menu.
- 2 Turn the V1 knob to select [Startup Define], and press the V4 knob.

<input type="checkbox"/>	0001	Rate 30	SS	Mon PGM
Setup				1/11
Startup Define				
System				▶
Audio				▶▶
Video (Input)				▶▶▶
Select			Store	↓ Enter

The effect, key, and setup settings are saved.

Tip

When settings are saved, the [Startup Mode] automatically changes to [User].

Note

The current settings will be lost if the unit is turned off without saving.

Selecting the Settings Recalled at Startup

- 1 Press the SETUP button to display the [Setup] menu.
- 2 Turn the V1 knob to select [System], and press the knob.

0001	Rate 30	SS	Mon PGM
Setup			2/11
Startup Define			
System			▶
Audio			▶
Video (Input)			▶
Select			
↓ Enter			

- 3 Turn the V1 knob to select [Startup Mode], turn the V4 knob to select the mode, and press the knob.

0001	Rate 30	SS	Mon PGM
System			5/8
REF OUT Phase			
Startup Mode			
Date			
Time			
Select			Def User

Knob	Parameter	Meaning	Setting values
V4	Def	Recalled settings	Fact, User

Notes on setting values

Fact: Factory default settings

User: Saved settings

Appendix

Effect Pattern List

Wipe

1		2		3	
4		5		6	
7		8		9	
10		11		12	
13		14		15	
16		17		18	
19		20		21	
22		23		24	

Mix

900	
-----	--

NAM (non-additive mix)

901	
-----	--

Slide

1001		1002		1003	
1004		1005		1006	
1007		1008			

Squeeze

1021		1022		1023	
1024		1025		1026	
1027		1028		1029	
1030		1031			

Door

1041		1042		1043	
1044					

Frame In/Out

1201		1202		1203	
1204		1205		1206	
1207		1208		1221	
1222		1223		1224	

Flip Tumble¹⁾

1101		1102	
------	--	------	--

PinP (picture-in-picture)¹⁾

1251	
------	--

Mosaic¹⁾

1701	
------	--

Defocus¹⁾

1702	
------	--

1) Can only be used for BKGD transitions.

Troubleshooting

Please verify the problem again. If the problem persists, contact your local Sony representative.

Problem	Possible cause	Solution
The video output is not displayed and the display is black.	The FTB button is lit (on).	Turn the FTB button off.
The BKGD and KEY next transition buttons cannot be selected simultaneously.	DME wipe is selected for the effect transition type.	Select an effect transition type other than DME.
Cannot select DME wipe for the effect transition type.	DME is selected for the key transition type, or the resizer function is [On].	Select a key transition type other than DME, or turn the resizer function [Off].
Cannot select DME wipe for the key transition type.	DME is selected for the effect transition type, or the resizer function is [On].	Select an effect transition type other than DME, or turn the resizer function [Off].
[Resizer] cannot be turned [On].	DME wipe is selected for the effect transition or key transition type.	Select an effect transition or key transition type other than DME.
CG files do not appear in the list.	The file is not saved in the import folder.	Save the file in the "\Sony\MCS\FM" folder.
	The file name (including the extension) consists of 26 characters or more.	Edit the file name to 25 characters or less (including the extension).
Alpha channel video cannot be imported.	The CG files that include alpha channels were not created properly.	Create CG files that include alpha channels in TGA or TIFF format.
The menu selection buttons do not function.	Entry of an effect pattern number or snapshot number is in progress in the numeric keypad block.	Operate the menu after you finish entering the effect pattern number or snapshot number.
Movement to sub-menus (lower menu levels) is disabled.		
The FTB button in the transition control block does not function.	AUX 1 or AUX 2 is delegated to the cross-point control block (i.e., the AUX 1 or AUX 2 bus delegation button is selected).	Change the bus delegation button selection to BKGD or KEY.
	[Fade To Black] is set to [Disbl] in the [Setup] menu >[Video (Misc)] menu.	Set [Fade To Black] to [Enbl].
The KEY TRANS button in the transition control block does not function.	AUX 1 or AUX 2 is delegated to the cross-point control block (i.e., the AUX 1 or AUX 2 bus delegation button is selected).	Change the bus delegation button selection to BKGD or KEY.
The EFF button in the transition control block does not function.		
The KEY next transition button does not turn on (i.e., light).		
After configuring the date and time settings, the settings appear incorrectly after restarting the power.	If the date and time appear incorrectly, the internal battery may be weak.	Contact your local Sony representative.

Maintenance

Remove dust from the ventilation holes once a month or whenever the holes are dirty.

Specifications

General

Supported formats

1080i/ 50 Hz, 59.94 Hz
720p/ 50 Hz, 59.94 Hz
480i/ 59.94 Hz
576i/ 50 Hz

Power 100 to 240 V AC $\pm 10\%$, 50/60 Hz

Power consumption

100 V: 0.7 A, 240 V: 0.3 A

Inrush current

- (1) Maximum possible inrush current at initial switch-on (Voltage changes caused by manual switching):
40 A peak, 10 A r.m.s. (240 V AC)
- (2) Inrush current after a mains interruption of five seconds (Voltage changes caused at zero-crossing):
10 A peak, 5 A r.m.s. (240 V AC)

Operation guarantee temperature

5 °C to 40 °C (41 °F to 104 °F)

Performance guarantee temperature

10 °C to 35 °C (50 °F to 95 °F)

Storage temperature

-20 °C to +60 °C (-4 °F to +140 °F)

Dimensions

420 × 122 × 265 mm
(16 ⁵/₈ × 4 ⁷/₈ × 10 ¹/₂ in.)
(WHD, excluding protrusions)

Mass

Approx. 5.0 kg (13 lb. 4 oz.)

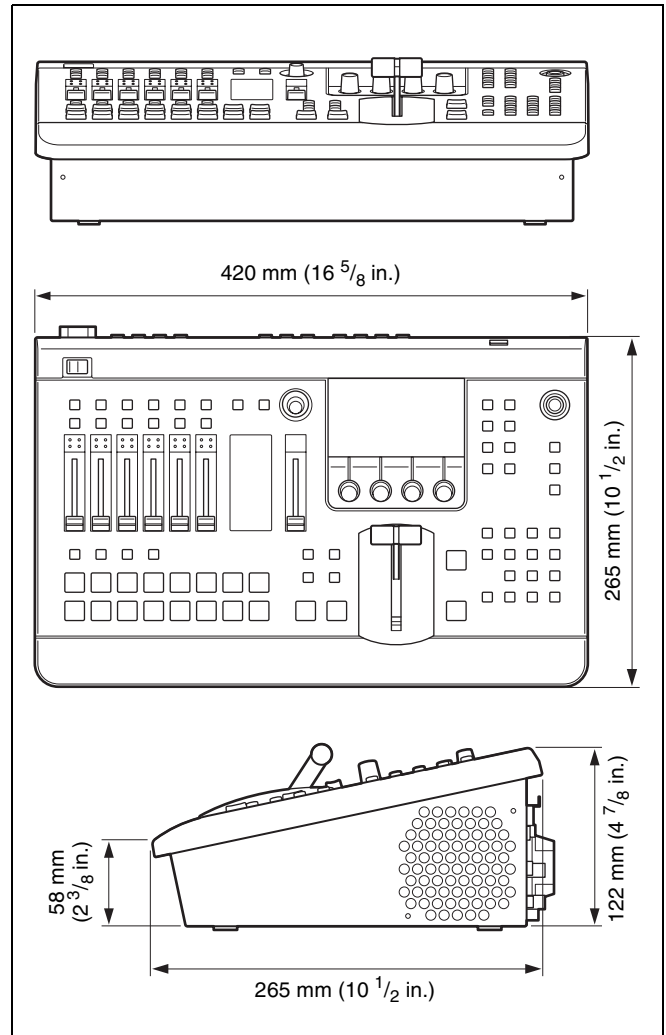

Appendix

Video signals

Video input

- SDI BNC (4), 75 Ω , 0.8 Vp-p $\pm 10\%$,
1.5 Gbps, 270 Mbps
SMPTE-292M, SMPTE-299M,
SMPTE-259M-C, SMPTE-272M-A
- HDMI HDMI (Type A) (3)
HDCP not supported, CEC not supported
- DVI-I DVI (1) (DVI-IN)
HDCP not supported, digital/analog RGB
supported
- Composite BNC (3), 1 Vp-p ± 2 dB, negative sync
(75 Ω)
- Reference BNC (2), loop through 75 Ω
Analog black burst or tri-level sync signal
+6 dB to -3 dB reference value

Supported input formats

• HD/SD system

SD/HD	Input Format	SDI IN 1 to 4	HDMI IN 1 to 3	DVI-I IN		VIDEO IN 1 to 3	REF IN
				Digital	Analog ¹⁾		
SD	576i/50	576i/50	Not supported	Not supported	XGA (1024×768) / 60 SXGA (1280×1024) / 60 WXGA (1280×768) / 60	PAL	PAL BB
	480i/59.94	480i/59.94	Not supported	Not supported	XGA (1024×768) / 60 SXGA (1280×1024) / 60 WXGA (1280×768) / 60	NTSC	NTSC BB
HD	1080i/50	1080i/50	1080i/50	1080p/50	XGA (1024×768) / 60 SXGA (1280×1024) / 60 WXGA (1280×768) / 60	Not supported	PAL BB 1080i/50 (tri-level)
	1080i/59.94	1080i/59.94	1080i/59.94	1080p/60	XGA (1024×768) / 60 SXGA (1280×1024) / 60 WXGA (1280×768) / 60	Not supported	NTSC BB 1080i/59.94 (tri-level)
	720p/50	720p/50	720p/50	Not supported	XGA (1024×768) / 60 SXGA (1280×1024) / 60 WXGA (1280×768) / 60	Not supported	PAL BB 720p/50 (tri-level)
	720p/59.94	720p/59.94	720p/59.94	Not supported	XGA (1024×768) / 60 SXGA (1280×1024) / 60 WXGA (1280×768) / 60	Not supported	NTSC BB 720p/59.94 (tri-level)

1) WXGA (1280 × 768) supports only the following formats.

Resolution	Frequency (Hz)	fs (MHz)	fH (KHz)	fV (Hz)	H (pix)	V (line)
1280 × 768	60	68.250	47.396	59.995	1440	790

• 3D system (Single, Dual Stream)

SD/HD	Input Format	SDI IN 1 (L) 2 (R)	SDI IN 3 (L) 4 (R)	HDMI IN 1 to 3	DVI-I IN		VIDEO IN 1 to 3	REF IN
					Digital	Analog		
HD	1080i/50	1080i/50	1080i/50	Not supported	Not supported	Not supported	Not supported	PAL BB 1080i/50 (tri-level)
	1080i/59.94	1080i/59.94	1080i/59.94	Not supported	Not supported	Not supported	Not supported	NTSC BB 1080i/59.94 (tri-level)
	720p/50	720p/50	720p/50	Not supported	Not supported	Not supported	Not supported	PAL BB 720p/50 (tri-level)
	720p/59.94	720p/59.94	720p/59.94	Not supported	Not supported	Not supported	Not supported	NTSC BB 720p/59.94 (tri-level)

Video output

SDI	BNC (4), 75 Ω, 0.8 V _{p-p} ±10%, 1.5 Gbps, 270 Mbps SMPTE-292M, SMPTE-299M, SMPTE-259M-C, SMPTE-272M-A
DVI-D	DVI (2) (AUX, MULTI VIEWER) HDCP not supported
Composite	BNC (1), 1 V _{p-p} ±2 dB, negative sync (75 Ω) Output material identical to DVI-D (AUX) output
Reference	BNC (1), 75 Ω black burst signal, NTSC: 0.286 V _{p-p} ±2 dB, negative sync (75 Ω) PAL: 0.3 V _{p-p} ±2 dB, negative sync (75 Ω)

Supported output formats

• HD/SD system

SD/HD	Output Format	SDI OUT	DVI-D OUT		VIDEO OUT AUX	REF OUT
			PGM, AUX1, AUX2, MV ¹⁾	AUX		
SD	576i/50	576i/50	Not supported	576i/50	PAL	PAL BB
	480i/59.94	480i/59.94	Not supported	480i/59.94	NTSC	NTSC BB
HD	1080i/50	1080i/50	1080i/50	1080i/50	Not supported	PAL BB
	1080i/59.94	1080i/59.94	1080i/59.94	1080i/59.94	Not supported	NTSC BB
	720p/50	720p/50	720p/50	720p/50	Not supported	PAL BB
	720p/59.94	720p/59.94	720p/59.94	720p/59.94	Not supported	NTSC BB

• 3D system (Single, Dual Stream)

SD/HD	Output Format	SDI OUT	DVI-D OUT		VIDEO OUT AUX	REF OUT
			PGM, AUX1, AUX2, MV ¹⁾	AUX		
HD	1080i/50	1080i/50	1080i/50	1080i/50	Not supported	PAL BB
	1080i/59.94	1080i/59.94	1080i/59.94	1080i/59.94	Not supported	NTSC BB
	720p/50	720p/50	720p/50	720p/50	Not supported	PAL BB
	720p/59.94	720p/59.94	720p/59.94	720p/59.94	Not supported	NTSC BB

1) MV: MULTI VIEWER

Audio signals

Audio input

Analog input 1 and 2

XLR+TRS combo (2)

(MIC/LINE 1 and 2), male

Reference input level: -44 dBu, -20 dBu,
+4 dBu, input impedance: 3.3 kΩ or more

Analog input 3 to 6

TRS phone (4) (MIC/LINE 3 to 6)

Reference input level: -44 dBu, -20 dBu,
+4 dBu, input impedance: 3.3 kΩ or more

Analog input 7 and 8

Phono jack (2) (LINE 7 and 8)

Reference input level: -10 dBu,
input impedance: 10 kΩ or more

Audio output

Analog output 1 and 2

XLR (2) (PGM OUT L and R), female

Reference level: +4 dBu (10 kΩ load),
max. output level: +24 dBu,
output impedance: 150 Ω

Analog output TRS phone (4)

(AUX 1/AUX 2/MON L/MON R)

Reference level: +4 dBu (10 kΩ load),
max. output level: +24 dBu,
output impedance: 150 Ω

Analog output Phono jack (2) (MIX L/MIX R)

Reference level: 10 dBu (10 kΩ load),
max. output level: 10 dBu,
output impedance: 470 Ω

Headphones output

Standard stereo PHONE (1)
Max. output: 25 mW × 2 (16 Ω load)

Other interfaces

USB Type A (1)
REMOTE 9-pin D-sub (1), male, RS-232C,
38.4 k Baud
TALLY/GPI 15-pin D-sub (1), male
Input: 4 ch, output: 8 ch Open Corrector
(max. current 5 mA or less, max.
voltage 5 V or less)

Supplied accessories

75-Ω termination resistor (1)
Operating Instructions (Volume I Basic Operation)
(Japanese and English, 1 each) (this document)
CD-ROM (Operating Instructions (Volume I Basic
Operation/Volume II Advanced Settings)) (1)
Warranty (1)

Optional accessories

- ① AC power code (for USA and Canada)
125 V, 10 A, 2.4 m (7 ft. 10 1/2 in.)
Part number: 1-551-812-31
- ① AC power code (for Europe)
250 V, 10 A, 2.5 m (8 ft. 2 1/2 in.)
Part number: 1-782-929-12
- ① AC power code (for China)
250 V, 10 A, 1.83 m (6 ft. 1/2 in.)
Part number: 1-830-860-11
- ② Holder, Plug (Black)
Part number: 2-990-242-01

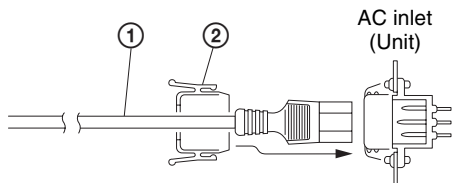

Design and specifications are subject to change without notice.

- Always make a test recording, and verify that it was recorded successfully.
SONY WILL NOT BE LIABLE FOR DAMAGES OF ANY KIND INCLUDING, BUT NOT LIMITED TO, COMPENSATION OR REIMBURSEMENT ON ACCOUNT OF FAILURE OF THIS UNIT OR ITS RECORDING MEDIA, EXTERNAL STORAGE SYSTEMS OR ANY OTHER MEDIA OR STORAGE SYSTEMS TO RECORD CONTENT OF ANY TYPE.
- Always verify that the unit is operating properly before use. SONY WILL NOT BE LIABLE FOR DAMAGES OF ANY KIND INCLUDING, BUT NOT LIMITED TO, COMPENSATION OR REIMBURSEMENT ON ACCOUNT OF THE LOSS OF PRESENT OR PROSPECTIVE PROFITS DUE TO FAILURE OF THIS UNIT, EITHER DURING THE WARRANTY PERIOD OR AFTER EXPIRATION OF THE WARRANTY, OR FOR ANY OTHER REASON WHATSOEVER.

Pin Configurations

TALLY/GPI connector

15-pin D-sub, male

Pin No.	Signal name	Description
1	GPO1	GPI output 1 / tally 1
2	GPO2	GPI output 2 / tally 2
3	GPO3	GPI output 3 / tally 3
4	GPO4	GPI output 4 / tally 4
5	GPO5	GPI output 5 / tally 5
6	GPO6	GPI output 6 / tally 6
7	GPO7	GPI output 7 / tally 7
8	GPO8	GPI output 8 / tally 8
9	GND	GND
10	GND	GND
11	GPI1	GPI input 1
12	GPI2	GPI input 2
13	GPI3	GPI input 3
14	GPI4	GPI input 4
15	GND	GND

REMOTE connector

RS-232C, 9-pin D-sub, male

Pin No.	Signal name	Description
1	-	No Connection
2	RX	Received Data
3	TX	Transmitted Data
4	DTR	Data Terminal Ready
5	GND	Ground
6	DSR	Data Set Ready
7	RTS	Request to Send
8	CTS	Clear to Send
9	-	No Connection

Example Connection of GPI Input

Switch or relay connection

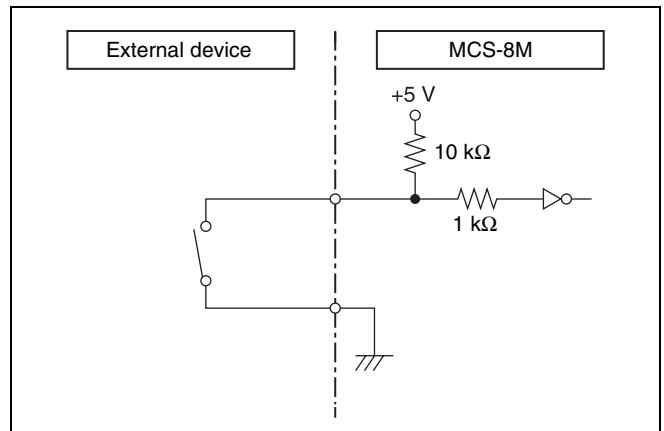

Open collector connection

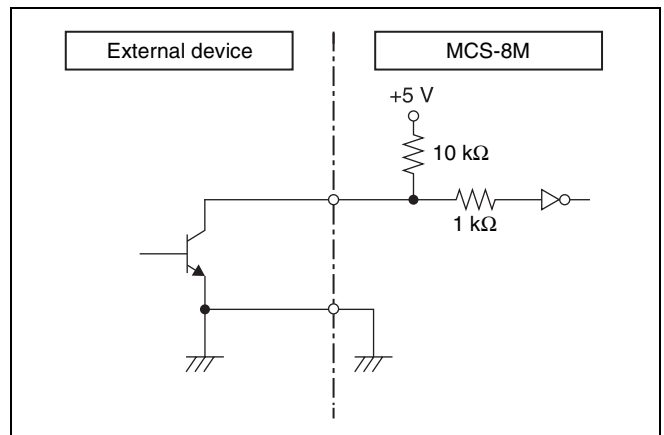

Example Connection of Tally/GPI Output

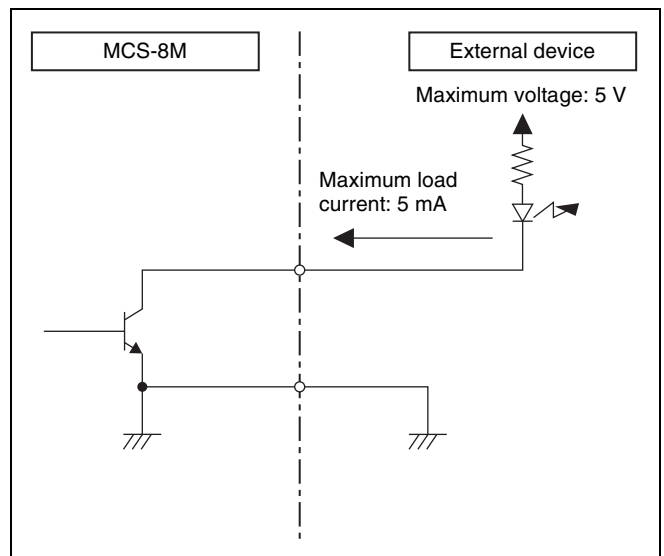

Index

Numerics

3D Mode II-41, II-48
3D System II-40
8/SHIFT I-11

A

ACCESS/PFL Button I-9, I-33, II-31
Adjustment Knobs 1 to 4 I-10
 Incremental Adjustment I-11
Aspect II-17, II-26, II-30
Aspect Ratio I-17
Audio I-21, I-32
 Mixing I-32
 Monitoring I-33
Audio Channel Menu II-31
 AUX OUT Assign II-33
 Equalizer High II-32
 Equalizer Low II-32
 Equalizer Mid II-32
 Filter II-31
 Input Trim II-31
 Limiter/Compressor II-32
 MIX OUT Assign II-33
 Pan II-32
 PGM Assign II-33
Audio Control Block I-9
Audio Input Assign I-21, II-49
Audio Input Block I-13
Audio Input Signals I-21
Audio Inputs I-22
Audio Level Meters I-9, I-33
Audio Menu II-49
 Audio Input Assign II-49
 Audio Output Delay II-50
 MIC/LINE Level II-49
 Oscillator II-50
 Output Level II-50
 SDI OUT AUX Assign II-50
 SDI OUT MULTI VIEWER
 Assign II-50
 SDI OUT PGM Assign II-49
Audio Mixing II-31
Audio Monitor I-10
Audio Output Block I-13
Audio Output Delay II-50
Auto Adjust Execute I-32, II-27
Auto Chromakey Menu II-27
 Auto Adjust Execute II-27
 Sample Mark II-27
 Sample Mark Adjust II-27
AUTO TRANS Button I-11, I-26, II-8
AUX 1 and 2 Buttons I-11

AUX OUT Assign II-33

B

BKGD Button I-11, I-12, I-35
Border Adjust II-25
Border Matte Adjust II-25
Bus Delegation II-9
Bus Delegation Button
 I-11, I-29, I-35, II-9, II-19
 AUX 1 and 2 Buttons I-11, II-9
 BKGD Button I-11, I-35, II-9
 KEY Button I-11, I-29, I-35, II-9,
 II-19, II-20

C

CH ON Button I-9, I-32
Channel Fader I-9, I-21, I-32, II-31
Chr I-31
Chr Key Adjust II-28
Chr Key Window II-28
Chr Key Window Adj II-28
Chroma Key I-28, I-30
 Detailed Adjustments II-21
Chromakey Auto Adj I-31, II-24
Chromakey Manual Adj II-24
Color BKGD II-8
Color Cancel II-28
Color Cancel Adjust II-28
Compressor II-32
Configuration Data II-37
Crop H II-18
Crop V II-18
Cropping II-13
Cross-Point Button I-19, I-25
 Assigning Video Signals I-19
 Switching I-25
Cross-Point Control Block I-11
CUT Button I-11, I-25

D

Date I-18
Date and Time I-18
Defocus I-37
Digital Multi Effect II-7, II-20
DIM Button I-9, I-33
Dimmer I-33
Direct Selection I-27
DIRECT/ESC Button I-12, I-28
DME II-7, II-20
DME Wipe II-13
 Basic Operations II-13
 Detailed Adjustments II-13
DME Wipe Adjust II-15
DME Wipe Bkgd Color II-16
DME Wipe Edge II-16
DME Wipe Edge Color II-16

DME Wipe Modify Menu II-18
 Crop H II-18
 Crop V II-18
 Positioner II-18
 Positioner Adjust II-18
 Size II-18
Door I-37
DVI I-20, II-51
DVI Input Signals II-51
DVI OUT AUX Assign II-53
DVI OUT MULTI VIEWER
 Assign II-53
DVI Video Inputs I-20

E

EFF Button I-10, I-11, I-12, I-28, I-29,
 I-30, II-10, II-15, II-19
Effect I-26
Effect Menu II-15
 DME Wipe Adjust II-15
 DME Wipe Bkgd Color II-16
 DME Wipe Edge II-16
 DME Wipe Edge Color II-16
 Effect Transition II-15
 Wipe Adjust II-15
 Wipe Edge II-15
 Wipe Edge Color II-15
Effect Pattern List I-37
Effect Transition II-15
Effects I-26
ENTER Button I-12, I-28, I-34
Equalizer II-32
Equalizer High II-32
Equalizer Low II-32
Equalizer Mid II-32
Export II-36
Export Config II-37
Export Snapshot II-38
Exporting II-36, II-37, II-38
 Configuration Data II-37
 Frame Memory II-36
 Snapshot II-38

F

F1 and F2 Buttons I-10
Fade To Black II-54
Fader Lever I-12, I-26
FILE Button I-10, II-37
File Menu II-37, II-38, II-39
 Export Config II-37
 Export Snapshot II-38
 Import Config II-38
 Import Snapshot II-39
 USB Memory Format II-39
Fine Key II-25
Fine Key Adjust H II-25

Fine Key Adjust V II-25
 Flip Tumble I-37
 FM Button I-10, II-34
 Formatting USB Flash Drive II-39
 Frame In/Out I-26, I-37
 Frame Memory II-34
 Frame Memory Freeze II-35
 Frame Memory Menu
 II-34, II-35, II-36
 Export II-36
 Frame Memory Freeze II-35
 Import II-36
 Input Freeze II-34
 Select II-35
 Freezing II-34
 Front Panel I-9
 FTB Button I-11, II-8, II-54

G

GPI Input I-42, II-43, II-44
 GPI Output I-42, II-43
 GPI Output/Tally II-45
 GPI/Tally Menu II-44
 GPI Input II-44
 GPI Output/Tally II-45
 On Air Source II-46

H

HDMI II-51

I

Import II-36
 Import Config II-38
 Import Snapshot II-39
 Importing II-36, II-38, II-39
 Configuration Data II-38
 Image II-36
 Snapshot II-39
 Information II-54
 Input Freeze II-34
 Input Reference Signals II-47
 Input Signal Indicator I-9, I-22
 Input Trim II-31

K

Key I-28, II-19
 Basic Operations II-19
 Detailed Adjustments II-20
 KEY Button I-10, I-11, I-12, I-29,
 I-35, II-19, II-20, II-23
 Key DME Wipe II-24
 Key DME Wipe Modify Menu II-30
 Positioner II-30
 Positioner Adjust II-30
 Size II-30

Key Edge Type II-25
 Key Fill Mat Adjust II-23
 Key Fill/Src Select II-23
 Key Invert II-24
 Key Mask II-25
 Key Mask Box H II-25
 Key Mask Box V II-25
 Key Menu II-23
 Border Adjust II-25
 Border Matte Adjust II-25
 Chromakey Auto Adj II-24
 Chromakey Manual Adj II-24
 Fine Key II-25
 Fine Key Adjust H II-25
 Fine Key Adjust V II-25
 Key DME Wipe II-24
 Key Edge Type II-25
 Key Fill Mat Adjust II-23
 Key Fill/Src Select II-23
 Key Invert II-24
 Key Mask II-25
 Key Mask Box H II-25
 Key Mask Box V II-25
 Key Soft Edge II-25
 Key Transition II-23
 Key Type Select II-23
 Key Wipe II-24
 Key Wipe Edge II-24
 Lin Key Adjust II-23
 Lin Key Mode II-24
 Lum Key Adjust II-23
 Lum Key Mode II-23
 Resizer II-23
 Key Soft Edge II-25
 KEY TRANS Button
 I-12, II-8, II-20, II-23
 Key Transition II-20
 Key Type II-21
 Key Type Select I-29, I-31, II-23
 Key Wipe II-24
 Key Wipe Edge II-24
 Key Wipe Modify Menu II-29
 Aspect II-30
 Multi II-30
 Multi Adjust II-30
 Positioner II-29
 Positioner Adjust II-29
 Rotation II-29
 Rotation Adjust II-29

L

LCD Backlight II-48
 Limiter II-32
 Limiter/Compressor II-32
 Lin Key Adjust II-23
 Lin Key Mode II-24
 Linear Key I-28, II-21

Location II-26
 Lum I-29
 Lum Key Adjust II-23
 Lum Key Mode II-23
 Luminance Key I-28, I-29, II-21

M

Manual Chromakey Menu II-28
 Chr Key Adjust II-28
 Chr Key Window II-28
 Chr Key Window Adj II-28
 Color Cancel II-28
 Color Cancel Adjust II-28
 Menu
 Operations I-11
 Viewing I-10
 Menu Control Block I-10
 Menu Selection Button I-10
 EFF Button I-10, II-15
 FILE Button I-10, II-37
 FM Button I-10, II-34
 KEY Button I-10, II-23
 MENU1 and 2 Buttons I-10
 MISC Button I-10, II-8
 SETUP Button I-10, I-17, I-18,
 I-19, I-20, II-47
 MENU1 and 2 Buttons I-10
 Message List II-55
 MIC/LINE Level I-22, II-49
 MISC Button I-10, II-8
 Misc Menu II-8
 Color BKGD II-8
 Port Enable II-8
 Transition Rate II-8
 Mix I-26, I-27, I-37, II-20
 MIX Button
 I-11, I-27, I-29, I-30, II-19
 MIX OUT Assign II-33
 MONITOR LEVEL Adjustment
 Knob I-9, I-33
 MONITOR SEL Button I-9, I-33
 Mosaic I-37
 Multi II-17, II-30
 Multi Adjust II-17, II-30
 Multi Viewer I-23

N

NAM I-37, II-7
 Next Transition Selection Button I-11
 BKGD Button I-11, I-12
 KEY Button I-11, I-12
 Non-Additive Mix II-7
 Numeric Buttons (0 to 9) I-12, I-27
 Numeric Keypad I-27
 Numeric Keypad Block I-12

O

On Air Source II-46
Oscillator II-50
Output Level II-50

P

Pan II-32
Peak Indicator I-9, I-22
PFL I-33
PGM Assign II-33
PGM Cross-Point Button
I-11, I-19, I-25
Pin Configurations I-42
PinP I-37, II-13
Port Enable II-8
POS Button I-10, II-11, II-13
Positioner II-16, II-18, II-29
Positioner Adjust
II-16, II-18, II-29, II-30
Pre-Fade Listen I-33
Preview Video I-23
Program Fader I-9, I-32
Program Video I-23
PST/KEY Cross-Point Button
I-11, I-19, I-25

R

REF OUT Phase II-48
Reference Signal Input/Output
Block I-14
Resizer II-23
Resizer Menu II-26
Aspect II-26
Location II-26
Rotation II-27
Rotation Mode II-26
Rotation II-17, II-29
Rotation Adjust II-17, II-29
Rotation Mode II-26

S

Sample Mark I-31, II-27
Sample Mark Adjust I-31, II-27
Saving Settings I-35
SDI II-51
SDI OUT AUX Assign II-50, II-53
SDI OUT MULTI VIEWER
Assign II-50, II-53
SDI OUT PGM Assign II-49, II-53
Select II-35
Setup II-47
SETUP Button
I-10, I-17, I-18, I-19, I-20, II-47
Setup Menu II-44, II-47, II-49, II-51,
II-52, II-53, II-54

Audio II-49
GPI/Tally II-44
Information II-54
Install II-54
Multi Viewer I-23
Startup Define I-35
System II-47
Video (Input) II-51
Video (Misc) II-54
Video (Output) II-53
Video (XPT) II-52

SHIFT II-52
Signal Assign I-23
Signal Format I-17
Size II-18
Slide I-37
Snapshot I-34, II-38
Recalling I-34
Saving I-34
SNAPSHOT Button I-12, I-34
Specifications I-39
Squeeze I-37
Startup Define I-35
Startup Mode II-48
STORE Button I-12, I-34
System Configuration Example
3D System II-6
HD System I-8
SD System II-5
System Format I-17, II-48
System Menu II-48
3D Mode II-48
Date II-48
LCD Backlight II-48
REF OUT Phase II-48
Startup Mode II-48
System Format II-48
System Reference II-48
Time II-48
System Reference II-48

T

Tally Input I-42
Tally Output II-43
Time I-18
Transition Control Block I-11
Transition Indicator I-11, I-27
Transition Rate I-27, II-8
Transition Rate Area I-10
Transition Type II-7
Transition Type Selection Button
I-11
EFF Button
I-11, I-29, I-30, II-10, II-19
MIX Button
I-11, I-27, I-29, I-30, II-19
Troubleshooting I-38

Turning the Unit On/Off I-16

U

USB Memory Format II-39

V

V1 I-11
V2 I-11
V3 I-11
V4 I-11
VIDEO II-51
Video (Input) I-20
Video (Input) Menu II-51
DVI II-51
HDMI II-51
SDI II-51
VIDEO II-51
Video (Misc) Menu II-54
Fade To Black II-54
Switch Timing II-54
Video (Output) Menu II-53
DVI OUT AUX Assign II-53
DVI OUT MULTI VIEWER
Assign II-53
SDI OUT AUX Assign II-53
SDI OUT MULTI VIEWER
Assign II-53
SDI OUT PGM Assign II-53
VIDEO II-53
Video (XPT) I-19
Video (XPT) Menu II-52
XPT Assign II-52
XPT Shift Mode II-52
Video Input Block I-14
Video Output Block I-14
Video Switching I-25, II-7
Viewer Mode I-23

W

Wipe I-26, I-37, II-7, II-10, II-20
Wipe Adjust II-15
Wipe Edge II-12, II-15
Wipe Edge Color II-15
Wipe Modify Menu II-16
Aspect II-17
Multi II-17
Multi Adjust II-17
Positioner II-16
Positioner Adjust II-16
Rotation II-17
Rotation Adjust II-17
Wipe Patterns II-11

X

XPT Assign I-19, II-52

XPT Shift Mode II-52
X-Y Pointer I-10, II-11, II-13



Index

The material contained in this manual consists of information that is the property of Sony Corporation and is intended solely for use by the purchasers of the equipment described in this manual.

Sony Corporation expressly prohibits the duplication of any portion of this manual or the use thereof for any purpose other than the operation or maintenance of the equipment described in this manual without the express written permission of Sony Corporation.

Trademarks

HDMI, the HDMI logo and High-Definition Multimedia Interface are trademarks or registered trademarks of HDMI Licensing LLC.

Other products or system names appearing in this document are trademarks or registered trademarks of their respective owners.

Further, the ® or ™ symbols are not used in the text.

For Customer in China

根据中华人民共和国信息产业部第39号令《电子信息产品污染控制管理办法》及标准中要求的“有毒有害物质或元素名称及含量”等信息，本产品相关信息请参考以下链接：

<http://pro.sony.com.cn>

出版日期：2011年8月

<http://www.sony.net/>

Sony Corporation

Printed in China